

PENTAX®

DistAngular

— DA-020F —

INSTRUCTION MANUAL

Before using this product, be sure that you have thoroughly read and understood this instruction manual to ensure proper operation.

After reading this manual, be sure to keep in a convenient place for easy reference.

ASAHI PRECISION CO., LTD.

PRECAUTIONS REGARDING SAFETY

1. Safety Precautions (Must be Followed)

The following items are intended to prevent possible injury to user or other people and / or damage to the instrument before it occurs. These safety precautions are important to the safe operation of this product and should be observed at all times.

■ Distinctive Displays

The following displays are used to distinguish precautions by the degree of injury or damage that may result if the precaution is ignored.



WARNING

Items indicated by this display are precautions, which, if ignored, could result in death or severe injury.



CAUTION

Items indicated by this display are precautions, which, if ignored, may result in injury or material damage.

- * Here "injury" refers to injuries such as cuts, burns or electric shock the treatment of which will not likely require hospitalization or long-term attention.
- * "Material damage" refers to damage to facilities, building, acquired data, etc.

■ Meanings of symbols

The following symbols precede the precautions so that the reader can understand the scope of the precaution at a glance.



:General caution













:General prohibition



:Disassembly prohibition



:Requirement General

 WARNING	
	Never use the telescope to view intense light such as direct sunlight or sunlight reflected through a prism as this may result in loss of sight.
	Do not use this product in a coal mine, in a location where there is coal dust, or near flammable material as there is a risk of explosion.
	Do not disassemble, modify or repair this product as there is a risk of fire, electric shock and burn injury. If you think the product requires repair, contact the retail outlet where you purchased it or an authorized repair site.
	Only use the BC01 or BC02 battery charger intended for this product as the battery charger. Use of another battery charger entails a risk of fire or burn injury from the battery bursting into flames due to possible differences in voltage or polarity.
	Do not use a damaged electric cord plug or loose electric outlet when charging as there is a risk of fire or electric shock.
	Do not charge the battery while covered by clothes or similar item as there is a risk of fire if the clothes ignite.
	Do not use the battery or charger when wet as there is a risk of fire and burn injury due to short-circuit.
	To prevent making a short-circuit when removing the battery and charger from the case and storing them, apply electrically resistant tape to the poles of the battery. Storing the battery and charger as-is may result in fire or burn injury due to short-circuit.
	Do not throw the battery into a fire or expose it to heat as there is a risk of injury if it explodes.



CAUTION



Do not remove the top handle without good reason. If it does come off, be sure to attach it securely to the instrument with screws. If it is not fastened securely, the instrument may fall when you grasp the top handle, leading to possible injury.



Do not short the poles of the battery or charger as there is a risk of injury or fire.



Do not touch any fluid which may leak from the battery as there is a risk of chemical burn injury or reaction.



Do not insert or remove the electric plug with wet hands as there is a risk of electric shock.



Do not use the case to stand on as it is slippery and unstable and may cause you to fall, resulting in possible injury.



Be sure the tripod itself and the instrument on the tripod are both installed securely as insecure installation may cause the tripod to fall over or the instrument to drop, resulting in possible injury.



Do not carry the tripod with the metal shoe pointing toward another person as the person may be injured if they strike him or her.



Tighten the tribrach clamp securely. Failure to properly secure the handle could result in the tripod legs extending while being carried, causing injury.



When mounting the instrument to the tripod, tighten the centering screw securely. Failure to tighten the screw properly could result in the instrument falling off the tripod causing injury.



Check that hands and feet are not in the vicinity of the tripod legs when erecting the tripod. A hand or foot stab wound could occur.



Do not wield or throw the plumb bob. A person could be injured if struck.

2. Usage Precautions

Surveying instruments are high-precision devices. In order to assure that the DistAngular which you have purchased will provide long-lasting maximum performance, the precautions in this manual must be followed. Be sure to follow these instructions and use this product properly at all times.

2-1 Solar Observation



WARNING

Never view the sun directly using the telescope as this may result in loss of sight.

Never point the objective lens directly at the sun as this may damage internal components.

2-2 Confirming a prism constant

Confirm the prism constant of the prism surely before measuring a distance. Change the prism constant of the prism which you use if the constant is not correct. (Refer to page 30 or 32 of the prism constant change.)

The corrected prism constant is stored in the instrument even if power is turned off.

2-3 Battery and Charger



WARNING

Use only the charger provided as standard accessory for charging the batteries. Using a different charger could result in a fire or injury due to a different voltage or \oplus/\ominus terminals. Mechanical damage could also result.

- If water gets on the battery or charger, immediately wipe and dry.
- Turn off the power when removing the battery from the instrument. Removing the battery while the power is still on may result in damage to the instrument.
- Before beginning work be sure to check the remaining battery charge. If the charge is insufficient, charge the batteries or use fully charged batteries.
- The battery mark indicated on the instrument is only an estimate of remaining battery power and is not completely accurate. Replace the battery quickly when it is about to run down as the time a battery lasts on one charge differs depending on conditions of use, ambient temperature, and the measurement mode of the instrument.

2-4 Storage and Operating Environment



WARNING

To prevent making short-circuit when removing the battery from the case and storing them, apply electrically resistant tape to the poles of the battery. Storing the battery as it is may result in fire or burn injury due to short-circuit.

- a. When an instrument has been used in rain or gotten wet, immediately dry it off and do not place it in the case until it is completely dry.
- b. After use, be sure to place the instrument in its case and avoid storing it in locations of high temperature, high humidity, severe vibration, or excess dust.
- c. The battery should be charged approximately once per month if the instrument is to be stored for an extended period of time. The instrument should also be removed from its case occasionally and aired out.
- d. Avoid storing the instrument in places subject to extreme high, low or radically fluctuating temperature. (Ambient temperature range during use : -10 °C to +50 °C)
- e. If there is a marked difference in temperature between the storage location and the usage location, to maintain accuracy let the instrument rest in the usage location until it reaches the same ambient temperature of the usage area. Also, when working in direct sunlight, use a parasol, etc., to shade the instrument.

2-5 Transporting and Carrying the Instrument

- a. Be careful to protect this instrument from shock of impact and excessive vibration which may result in damage during transportation and shipment.
- b. When transporting the instrument, always put it in the case and wrap shock-absorbing material around it and be sure it is handled as "FRAGILE".

2-6 Inspection and Repairs

Always inspect the instrument before beginning work and check that the instrument is maintaining the proper level of precision. Pentax bears absolutely no responsibility for damages due to survey results obtained from surveys conducted without an initial instrument inspection.



WARNING

Never disassemble the instrument, battery or charger even if you do detect an abnormality as there is a risk of fire or electric shock due to short-circuit. If you think the product requires repair, contact the retail outlet where you purchased it or an authorized repair site.

2-7 The others

Do not use an organic solvent, such as thinner or benzene to clean the instrument. If an organic solvent is used on plastic parts, the surface of the plastic will melt, deform, and/or discolor. To clean very dirty areas, wipe with a cloth soaked in a neutral cleaner.

In addition, make sure to follow the directions in this instruction manual to take correct measurements.

CONTENTS

Precautions Regarding Safety

1. Safety Precautions	back cover
2. Usage Precautions	3
2-1 Solar Observation	3
2-2 Confirming a prism constant	3
2-3 Battery and Charger	3
2-4 Storage and Operating Environment	4
2-5 Transporting and Carrying the Instrument	5
2-6 Inspection and Repairs	5
2-7 The others	5

1. Before Using the Instrument

1-1 Names of Parts	8
1-2 Unpacking and Packing	10
1-3 Attaching and Charging the Battery	11
1-4 Key Functions	14

2. Turning the Power ON

2-1 Turning the Power On and Off	16
2-2 Setting V. Angle 0 Point	17
2-3 Switching the Measurement Mode	18

3. Angle Measurement

3-1 Measuring an Angle	19
3-2 Resetting the Horizontal Angle to 0	20
3-3 Holding the Horizontal Angle	20
3-4 Setting an Arbitrary Horizontal Angle	21
3-5 Displaying the % Slope of the Vertical Angle	22
3-6 Changing the Horizontal Angle from Clockwise to Counterclockwise	23

4. Distance Measurement

4-1 Distance Measurement	24
4-2 Track Distance Measurement	26

5. Correction Mode	
5-1 Setting the Temperature	28
5-2 Setting the Atmospheric Pressure	29
5-3 Setting the Prism Constant	30
5-4 Setting the 90° buzzer	31
6. Initial Settings	
6-1 Overview	32
6-2 Initial Settings Mode	32
6-3 Entering the Mode for Initial Setting	34
6-4 Changing an Initial Setting	35
7. Preparation for Surveying	
7-1 Centering and Leveling of the Instrument	37
7-2 Eyepiece Adjustment and Aiming	40
8. Inspection and Adjustment	
8-1 Plate vial	42
8-2 Circular vial	43
8-3 Inclination of Reticle	44
8-4 Perpendicularity of Line of sight to horizontal axis	45
8-5 Vertical 0 point error	46
8-6 Optical Plummet	47
8-7 Offset Constant	48
8-8 Beam axis and Line of sight	49
9. Appendix	
9-1 Error Messages	50
9-2 Atmospheric Correction	51
9-3 hPa and mmHg Conversion Tables	52
9-4 Deviation of distance when no atmospheric correction is made ..	53
9-5 Atmospheric Refraction and Earth Curvature Correction ...	54
9-6 Distance Range	55
10. Specifications	56

1. BEFORE USING THE INSTRUMENT

1-1 Names of Parts

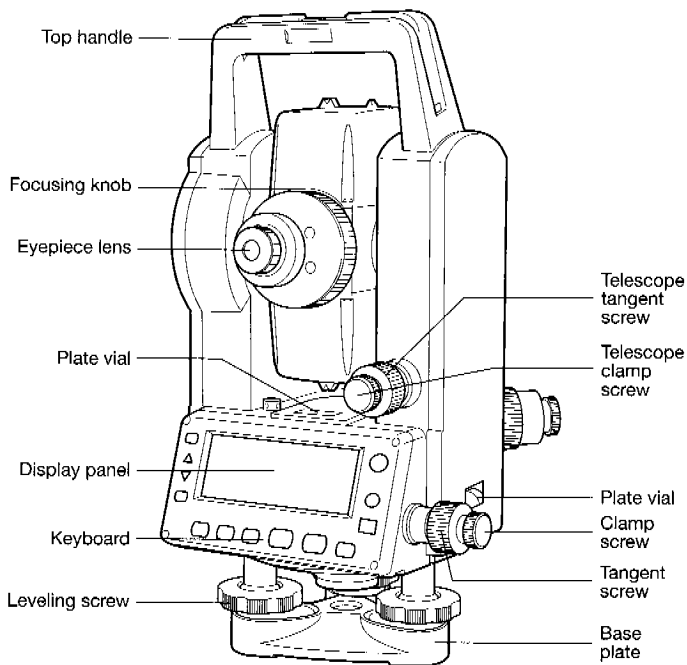

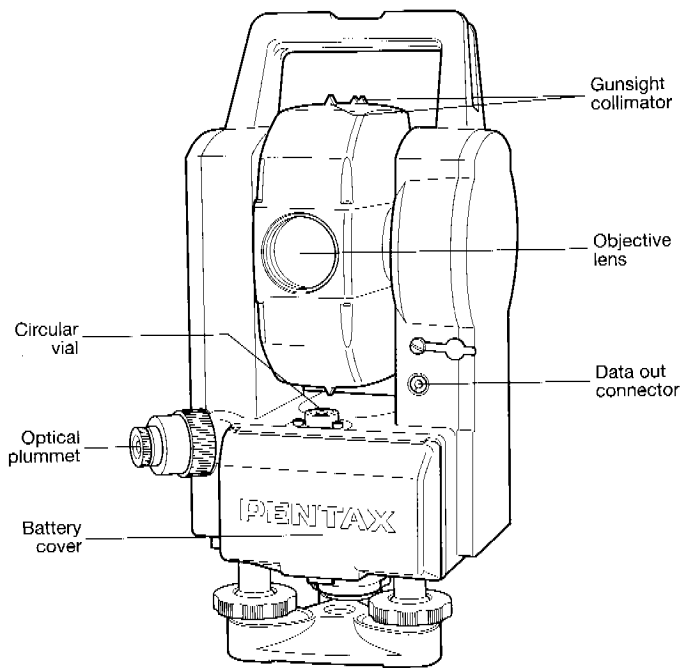

1-2 Unpacking and Packing

1-2-1 Unpacking the Instrument from the Case

- ① Gently set down the carrying case so that its cover is upward.
- ② Unlatch and open the case while pushing the latch lock.
- ③ Remember how the instrument is placed in the case before removing it.

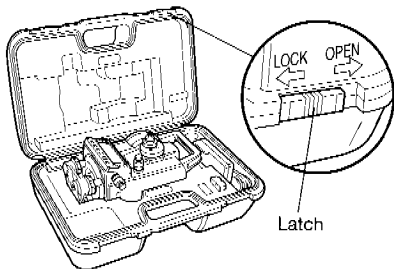

1-2-2 Packing the Instrument in the Case

- ① Set the telescope almost horizontal, and tighten the telescope clamp screw lightly.
- ② Tighten the horizontal clamp screw.
- ③ Store the instrument correctly into the case with the display facing up.
- ④ Close the case and secure the latch.

1-3 Attaching and Charging the Battery

1-3-1 Attaching the Battery

- ① Press the latch at the bottom of the battery cover, and open the battery cover.
- ② Align the ⊕ ⊖ marks on the surface of the battery pack with the ⊕ ⊖ marks on the battery box.
- ③ Slide the battery pack left to attach it to the instrument.
- ④ Close the battery cover.

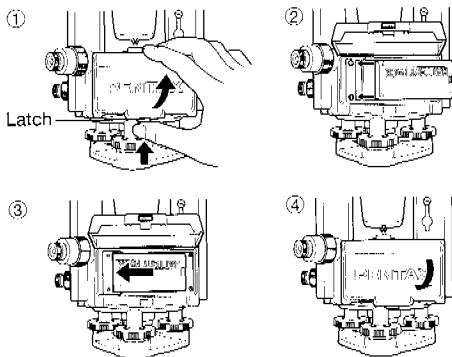

1-3-2 Removing the Battery

- ① Press the latch at the bottom of the battery cover, and open the battery cover.
 - ② Slide the battery pack to the right to remove it from the instrument.
- *Be absolutely sure to turn off the power when removing the battery as removing the battery while the power is still on may result in damage to the instrument.

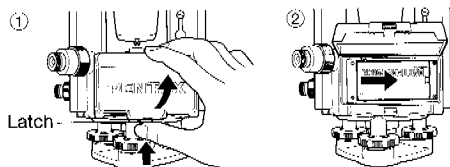

1-3-3 Remaining Battery Charge

When the power is turned on, a battery mark "■■■■" will be displayed on the right of the display screen. This mark can be used to check the charge status of the battery.

- } Plenty of charge left.
- }
- } Get the spare battery ready.
- } Replace with the spare battery.

BATT.

Please, change Replace with the spare battery or charge.

1-3-4 Charging the Battery

*The battery pack (BP01) shipped from the factory is not charged. Be sure to charge the battery before using it.

*Use only the charger, BC01 or BC02 to charge the battery, BP01.

① Align the ⊕⊖ marks on the battery pack rear surface with the ⊕⊖ marks on the charger.

② Slide the battery pack to set it in the charger.

③ When the charger is plugged into an AC outlet the power indicator light (red) turns on, and charging begins when the charging light flashes green. When charging is finished the charging indicator light changes from flashing green to constant green.

*The charger can charge two battery packs (BP01) at the same time.

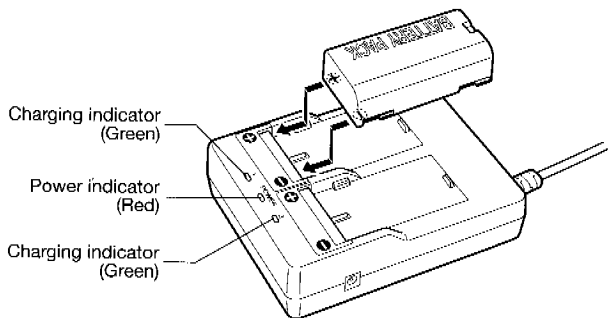





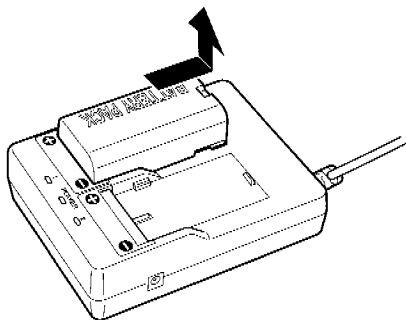





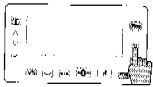

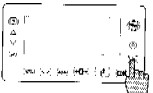

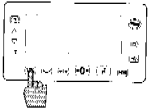

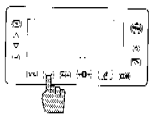
1-3-5 Removing from the Charger

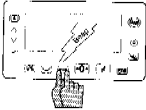
Slide the battery pack to remove it from the charger.



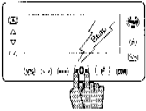
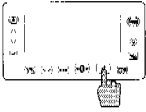
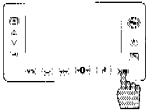

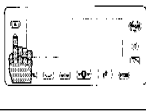
1-4 Key Functions

Key	Function
	<p> Key: Pressing this key turns the power on and off.</p>
	<p> Key: Pressing this key turns the illumination of the LCD display on and off.</p>
	<p> Key: Pressing this key switches the display composition in the order "Horizontal angle/Horizontal distance/Vertical distance", "Vertical angle/Slope distance/Vertical distance", and "Horizontal angle/Vertical angle/Slope distance".</p>
	<p> Key: Pressing this key alternates vertical angle % display and angle display.</p>
	<p> Key: Pressing this key alternates clockwise and counterclockwise of horizontal angle.</p>
	<p> Key: Pressing this key twice retains (holds) the horizontal angle shown on the display.</p>

Key	Function
	<p>(↔0↔) Key: Pressing this key twice resets the horizontal angle to 0°00'00".</p>
	<p>(→) Key: Pressing this key starts distance measurement. Pressing the key again stops distance measurement.</p>
	<p>(EDM) Key: Pressing this key switches the distance measurement modes in the order of normal/continuous distance measurement, normal/one shot distance measurement, track/continuous distance measurement, and track/one shot distance measurement.</p>
	<p>(S) Key: Pressing this key switches the setting modes in the order of temperature setting, pressure setting, prism constant setting, 90° buzzer on/off switch.</p>
	<p>(△) Key: Pressing these keys sets the temperature, pressure, prism constant, and 90° buzzer on/off.</p> <p>(▽) Key</p>
	<p>(→) Key: Pressing this key stores the temperature, pressure, prism constant, and 90° buzzer on/off setting.</p>

2. TURNING THE POWER ON

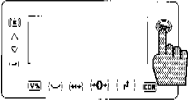
2-1 Turning the Power On and Off

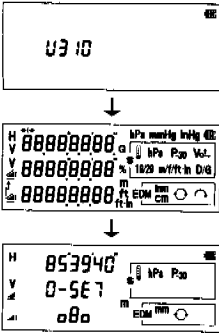
Operating Procedures	Displays																														
<p data-bbox="117 249 291 281">POWER ON</p>  <p data-bbox="117 477 518 599">Pressing the  key displays the version No. initial screen and a few seconds later displays the vertical angle zero setting screen, [0-5E7]·"000". (The  key is also used to turn the power off.)</p>	 <p>The display sequence is as follows:</p> <ul style="list-style-type: none"> Initial screen: U3 10 Intermediate screen: <table border="1" data-bbox="601 414 884 526"> <tr> <td>H</td> <td>88888888</td> <td>hPa</td> <td>mmHg</td> <td>hPa</td> <td>mmHg</td> </tr> <tr> <td>V</td> <td>88888888</td> <td>%</td> <td>hPa</td> <td>P₂₀</td> <td>Vol.</td> </tr> <tr> <td>0</td> <td>88888888</td> <td>m</td> <td>EDM</td> <td>mm</td> <td>cm</td> </tr> </table> Final screen: <table border="1" data-bbox="601 568 884 683"> <tr> <td>H</td> <td>853940</td> <td>hPa</td> <td>P₂₀</td> </tr> <tr> <td>V</td> <td>0-5E7</td> <td>m</td> <td>EDM</td> </tr> <tr> <td>0</td> <td>000</td> <td>mm</td> <td>cm</td> </tr> </table> 	H	88888888	hPa	mmHg	hPa	mmHg	V	88888888	%	hPa	P ₂₀	Vol.	0	88888888	m	EDM	mm	cm	H	853940	hPa	P ₂₀	V	0-5E7	m	EDM	0	000	mm	cm
H	88888888	hPa	mmHg	hPa	mmHg																										
V	88888888	%	hPa	P ₂₀	Vol.																										
0	88888888	m	EDM	mm	cm																										
H	853940	hPa	P ₂₀																												
V	0-5E7	m	EDM																												
0	000	mm	cm																												

- The Auto Power Off function will automatically turn the power off if no operations are performed for approximately 10 minutes.

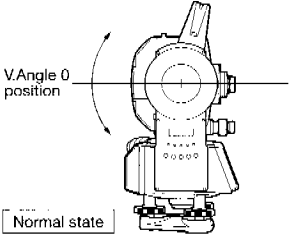
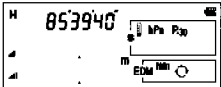

2-2 Setting V. Angle 0 Point

Operating Procedures	Displays
 <p>V.Angle 0 position</p> <p>Normal state</p> <p>After turning on the power, move the telescope up and down to pass through the V.Angle 0 position as instructed on the screen for setting V.Angle 0 point (0-5E7"000"). It makes possible to set the V.Angle 0 point and put the instrument into the mode for measuring Angle & Distance.</p>	

- The value displayed when the power was last time turned off will be displayed for the horizontal angle. If this horizontal angle is not needed, please perform horizontal angle 0 SET.

For details on changing to counterclockwise angle
 for the horizontal angle See page 23.
 For details on setting the horizontal angle to zero See page 20.
 For details on measuring the vertical angle See page 19.
 For details on distance measurements See page 24.

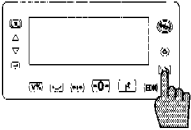

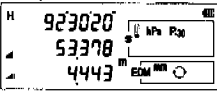
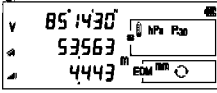
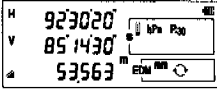

2-3 Switching the Measurement Mode

Operating Procedures	Displays
 <p>Use the  key to select measurement mode. Pressing the  key cycles through the sets of display items as shown on the right.</p>	<p>Display combination "Horizontal angle/Horizontal distance/Vertical distance"</p>  <p>↓</p> <p>Display combination "Vertical angle/Slope distance/Vertical distance"</p>  <p>↓</p> <p>Display combination "Horizontal angle/Vertical angle/Slope distance"</p> 

- Pressing the  key cycles through the sets of display items : "Horizontal angle/Horizontal distance/Vertical distance", "Vertical angle/Slope distance/Vertical distance", and "Horizontal angle/Vertical angle/Slope distance".

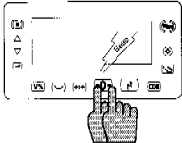
3. ANGLE MEASUREMENT

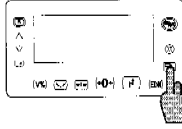
3-1 Measuring an Angle

Operating Procedures	Displays
<p>1</p>  <p>Aim at the first target, then press the 0 key twice in succession to reset the horizontal angle to 0.</p>	
<p>2</p> <p>Aim at the second target, then read the horizontal angle.</p>	
<p>3</p>  <p>Pressing the V key displays the vertical angle.</p>	

- The **0** key cannot reset the vertical angle to 0.
- Pressing the **V** key cycles through the sets of display items : “Horizontal angle/Horizontal distance/Vertical distance”, “Vertical angle/Slope distance/Vertical distance”, and “Horizontal angle/Vertical angle/Slope distance”.
- Even though you turn the power off during a survey, the horizontal angle displayed last time is saved, so that it is restored when the power is turned on next time.
- When the restored horizontal angle is not necessary, reset it to 0.

For details on setting the horizontal angle to zero	See page 20.
Minimum angle display setting	See page 33.
Angle unit setting	See page 33.
Azimuth Horizontal 0 compass switching	See page 33.

3-2 Resetting the Horizontal Angle to 0

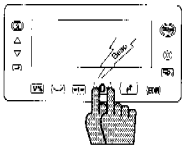
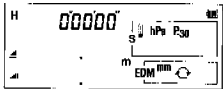
Operating Procedures	Displays
 <p>Pressing the 0 key twice in succession resets the horizontal angle to 0°00'00\".</p>	<p>Ex: Display combination "Horizontal angle/Horizontal distance/Vertical distance"</p> 

- The **0** key cannot reset the vertical angle to 0.
- Pressing the **0** key accidentally during measurement does not reset the horizontal angle to 0 unless you press it again. Once the buzzer stops sounding, you can go to the next step.
- The horizontal angle cannot be set to 0 during a measurement.
- The **0** key is enabled during "Horizontal angle/Horizontal distance/Vertical distance" or "Horizontal angle/Vertical angle/Slope distance" combination displays.



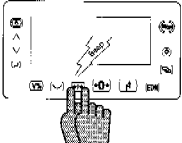
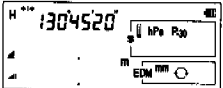

3-3 Holding the Horizontal Angle

Operating Procedures	Displays
 <p>To hold the horizontal angle currently being displayed, press the hold key twice in succession. The hold mark "H" will be displayed on the left side of the display screen when in the hold status.</p>	<p>Ex: Display combination "Horizontal angle/Horizontal distance/Vertical distance"</p> 



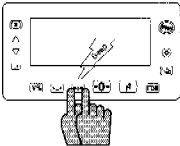

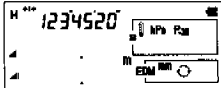
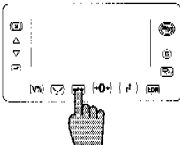
- The **hold** key cannot hold the vertical angle or distance.
- To release the horizontal angle from being held, press the **hold** key once.
- Pressing the **hold** key accidentally during measurement does not hold the horizontal angle unless you press it again. Once the buzzer stops sounding, you can go to the next step.
- The **hold** key is enabled during "Horizontal angle/Horizontal distance/Vertical distance" or "Horizontal angle/Vertical angle/Slope distance" combination displays.

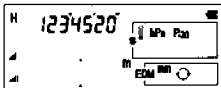
3-4 Setting an Arbitrary Horizontal Angle

In case of Horizontal angle 123°45'20" setting

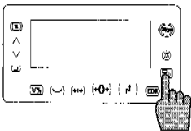

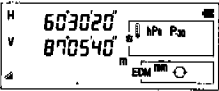
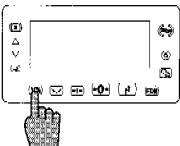
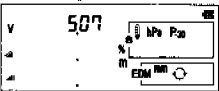
Operating Procedures	Displays
<p>1</p> <p>Use the horizontal clamp screw and horizontal tangent screw to display a horizontal angle of 123°45'20".</p>	<p>Ex: Combination display</p> <p>"Horizontal angle/Horizontal distance/Vertical distance"</p> 
<p>2</p>  <p>Press the  key twice hold at 123°45'20". The hold mark "H" will be displayed on the left side of the display screen.</p>	<p>Ex: Combination display</p> <p>"Horizontal angle/Horizontal distance/Vertical distance"</p> 
<p>3</p> <p>Use the horizontal clamp screw, horizontal tangent screw, telescope clamp screw, and telescope tangent screw to accurately aim at the target.</p>	
<p>4</p>  <p>Press the  key once to release the angle hold. The "H" hold mark will disappear from the left side of the display screen.</p>	



3-5 Displaying the % Slope of the Vertical Angle

Operating Procedures	Displays
<p>1</p>  <p>Press the [V] key to select the “Vertical angle/Slope distance/Vertical distance” or “Horizontal angle/Vertical angle/Slope distance” combination display and display the vertical angle.</p>	<p>Combination display “Vertical angle/Slope distance/Vertical distance”</p>  <p>Combination display “Horizontal angle/Vertical angle/Slope distance”</p> 
<p>2</p>  <p>Press the [V%] key to display the slope value in percentage.</p>	<p>Combination display “Vertical angle/Slope distance/Vertical distance”</p>  <p>Combination display “Horizontal angle/Vertical angle/Slope distance”</p> 

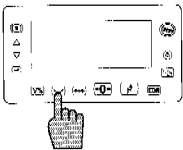
- A 0 percent represents the horizontal. +100 percent and -100 percent represent 45° up and down slopes, respectively.
- Press the **[V%]** key to return to the vertical angle display from the percent (inclination) display.
- If the slope (%) exceeds $\pm 1000\%$, “OVER” is displayed, indicating that the current vertical angle cannot be measured.
- When the telescope returns to a slope within slope $\pm 1000\%$, the slope (%) display returns automatically from the “OVER” message to the numeric value.

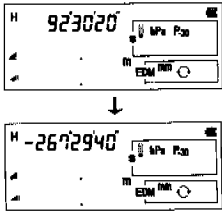



3-6 Changing the Horizontal Angle from Clockwise to Counterclockwise





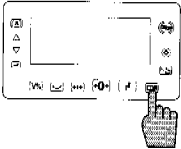

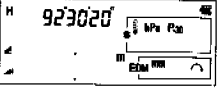
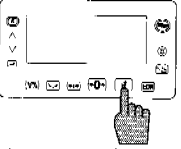
Operating Procedures	Displays
 <p>Press the  key to add a minus sign (-) to the horizontal angle value as a counterclockwise angle.</p>	<p>Ex: Combination display "Horizontal angle/Horizontal distance/Vertical distance"</p> 

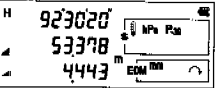
- The  key is only enabled during the "Horizontal angle/Horizontal distance/Vertical distance" or "Horizontal angle/Vertical angle/Slope distance" combination displays.
- Press the  key to return to the clockwise angle from the counterclockwise angle.
- When the counterclockwise horizontal angle is selected, the order of aiming at the targets becomes the reverse (the right one first, then the left one) of the order for the clockwise angle.

4. DISTANCE MEASUREMENT

4-1 Distance Measurement

Operating Procedures	Displays
<p>1</p>  <p><When measuring using Normal / Continuous measurement> Press the EDM key to display the "mm", that represents normal measurement, and the "∞", that represents continuous measurement, in the EDM mode at the bottom right of the display screen.</p> <p><When measuring using Normal / One shot measurement> Press the EDM key to display the "mm", that represents normal measurement, and the "↻", that represents one shot measurement, in the EDM mode at the bottom right of the display screen.</p>	<p>Normal/Continuous measurement</p>  <p>Normal/One shot measurement</p> 
<p>2</p>  <p>Aim the telescope at a prism and press the F key to start measuring the distance. When measurement starts the mode indicator "∞" or "↻" flashes. Upon reception of a reflected light from the prism, the device sounds the buzzer and displays the "F" mark to start measurement automatically.</p>	<p>Normal/Continuous measurement</p>  <p>Normal/One shot measurement</p> 

- Aiming at the prism and pressing the  key begins normal measurement while at the same time the mode indicator "" or "" begins to flash. For one shot measurement, the measurement ends at the same time the distance is displayed and the "" stops flashing. The "" will continue flashing during continuous measurement, but pressing the  key again will stop measurement and the flashing.
- Pressing the  key cycles through the sets of display items : "Horizontal angle/Horizontal distance/Vertical distance", "Vertical angle/Slope distance/Vertical distance", and "Horizontal angle/Vertical angle/Slope distance".
- Be sure to check the constant of the prism to be used.
- When return signal is not received for approximately 3 continuous minutes during measurement, measurement will automatically stop.
- The previously measured distance data is preserved until the next measurement is started and is, therefore, erased when measurement begins.

Distance unit setting	See page 33
Prism constant setting	See pages 30, 32

4-2 Track Distance Measurement

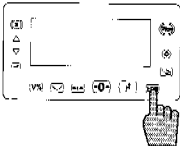
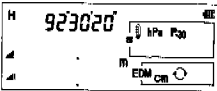
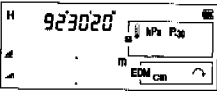
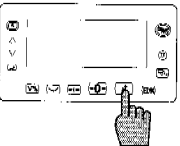
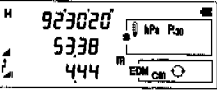
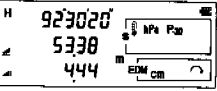
Operating Procedures	Displays
<p>1</p>  <p><When using Track/Continuous measurement> Press the EDM key to display the "cm", that represents track measurement, and the "∞", that represents continuous measurement, in the EDM mode at the bottom right of the display screen.</p> <p><When measuring using Track/One shot measurement> Press the EDM key to display the "cm", that represents track measurement, and the "↶", that represents one shot measurement, in the EDM mode at the bottom right of the display screen.</p>	<p>Track/Continuous measurement</p>  <p>Track/One shot measurement</p> 
<p>2</p>  <p>Aim the telescope at a prism and press the [F] key to start measuring the distance. When measurement starts, the mode display "∞" or "↶" flashes. Upon reception of a reflected light from the prism, the device sounds the buzzer and displays the "≠" mark to start measurement automatically.</p>	<p>Track/Continuous measurement</p>  <p>Track/One shot measurement</p> 



- Aiming at the prism and pressing the $\left[\overline{F} \right]$ key begins track measurement while at the same time the mode indicator "⊙" or "↻" begins to flash. For one shot measurement, the measurement ends at the same time the distance is displayed and the "↻" stops flashing. The "⊙" will continue flashing during continuous measurement, but pressing the $\left[\overline{F} \right]$ key again will stop measurement and the flashing.
- Pressing the $\left[\text{Menu} \right]$ key cycles through the sets of display items: "Horizontal angle/Horizontal distance/Vertical distance", "Vertical angle/Slope distance/Vertical distance", and "Horizontal angle/Vertical angle/Slope distance".
- Be sure to check the constant of the prism to be used.
- When return signal is not received for approximately 3 continuous minutes during measurement, measurement will automatically stop.
- The previously measured distance data is stored until the next measurement is started and is, therefore, erased when measurement begins.

Distance unit setting	See page 33
Prism constant setting	See pages 30, 32

5. CORRECTION MODE

5-1 Setting the Temperature

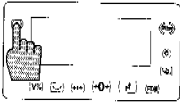
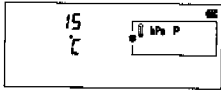

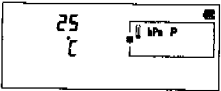
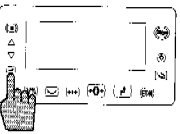
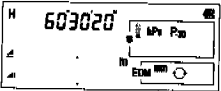
Example : Setting the temperature to +25°C

Operating Procedures	Displays
<p>1</p>  <p>Press the (TEMP) key once to change to "Temperature setting mode" as a correction mode.</p>	
<p>2</p>  <p>Use the (25) key to set the number 25. (Use the (Δ) key to increase the value and the (▽) key to decrease the value. The number will increase or decrease by one each time a key is pressed.)</p>	
<p>3</p>  <p>Press the (ENT) key to store the setting. (The display screen will return to the screen that was displayed before the (TEMP) key was pressed.)</p>	

- Once set, the temperature remains in memory even after the power is turned off.
- Calibration value setting mode: "C" flashes during temperature setting.
- The temperature setting range is -10°C to +50°C.
- At factory shipment the setting is +15°C.
- °F is set in the same manner.
- Temperature correction is based on 15°C. If this device is used without correcting the temperature, a distance error per 100 m is about -0.1 mm per +1°C as a temperature difference from 15°C. A distance error per 100 m is about 0.1 mm per -1°C as a temperature difference from 15°C. (For more accurate values, See page 53.)

5-2 Setting the Atmospheric Pressure

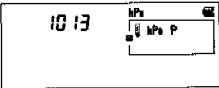
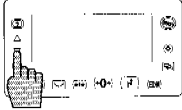

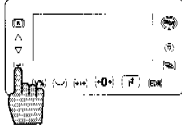
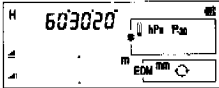

Example : Setting the pressure to 1000 hPa

Operating Procedures	Displays
<p>1</p>  <p>Press the (9) key twice to change to "Pressure setting mode".</p>	
<p>2</p>  <p>Use the (▽) key to set the number 1000. (Use the (△) key to increase the value and the (▽) key to decrease the value. The number will increase or decrease by one each time a key is pressed.)</p>	
<p>3</p>  <p>Press the (M) key to store the setting. (The display screen will return to the screen that was displayed before the (9) key was pressed.)</p>	

- Once set, the pressure remains in memory even after the power is turned off.
- Calibration value setting mode: "hPa" flashes during pressure setting.
- The Pressure setting range is 600 hPa to 1120 hPa.
- At factory shipment the setting is 1013hPa.
- mmHg and InHg are set in the same manner.
- Pressure correction is based on 1013 hectopascals (hPa). If this device is used without correcting the pressure, a distance error per 100 m is about -0.3 mm per -10 hPa as a pressure difference from 1013 hPa. (For more accurate values, See page 53.)

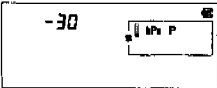
5-3 Setting the Prism Constant

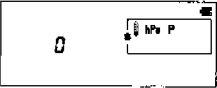



Select and set either "-30" or "0" for the prism constant.

Operating Procedures	Displays
<p>1</p>  <p>Press the (S) key three times to change to the "Prism constant setting" mode.</p>	
<p>2</p>  <p>Use the (Δ) key or (▽) key to select "-30" or "0".</p>	<p>When "-30" is selected.</p>  <p>When "0" is selected.</p> 
<p>3</p>  <p>Press the (L) key to store the setting. (The display screen will return to the screen that was displayed before the (S) key was pressed.)</p>	

- The prism constant is stored even when the power is turned off, so "P-30" or "P0" is displayed within the display screen right S (correction value mode).
- Correction value setting mode: "P" flashes during prism constant setting.
- At factory shipment the prism constant is "-30".

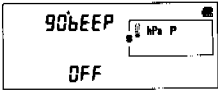
5-4 Setting the 90°buzzer

Select whether or not the buzzer is "On" or "OFF" for each 90° horizontal angle measurement (0°, 90°, 180°, 270°).

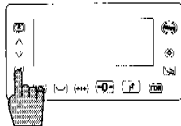
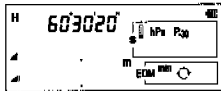
Operating Procedures	Displays
<p>1</p>  <p>Press the (90) key 4 times to change the correction value setting to the "90° buzzer setting" mode.</p>	
<p>2</p>  <p>Press the (Δ) key or (▽) key to select "On" or "OFF" respectively.</p>	<p>When "On" is selected.</p>  <p>When "OFF" is selected.</p> 
<p>3</p>  <p>Press the (M) key to store the setting. (The display screen will return to the screen that was displayed before the (90) key was pressed.)</p>	

- The set 90° buzzer is stored even when the power is turned off.
- Correction value mode: "90° beep" flashes during 90° buzzer setting.
- At factory shipment this setting is set to "OFF" (No 90° buzzer).

6. INITIAL SETTINGS

6-1 Overview

For the DistAngular, you can select and store the desired settings for a variety of prescribed instrument conditions, called initial settings.

Initial setting contains the 7 modes of Temperature unit setting, Pressure unit setting, Prism constant setting, Vertical angle formula setting, Minimum angle display setting, Distance unit setting, and Angle unit setting.

The settings at factory shipment are shown in bold letters in the display.

When a change is required, follow the instructions in "Entering Initial Settings" or "Changing Initial Settings" on page 35.

6-2 Initial Settings Mode

6-2-1 Temperature unit setting

Select either "°C" or "°F" for the Temperature unit.

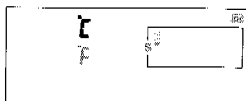

6-2-2 Pressure unit setting

Select "hPa", "mmHg", or "InHg" for the Pressure unit.

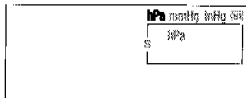

6-2-3 Prism constant setting

Select either "-30" or "0" for the prism constant.

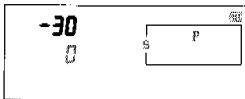

6-2-4 Vertical angle formula setting

Select "Zenith 0°", "Horizontal 0°", or "Compass scale" for the vertical angle 0 standard.

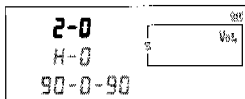

6-2-5 Minimum angle display setting

Select either 20" or 10" for the angle minimum display.

*When the angle unit is GRAD, select either "50cc" or "20cc."

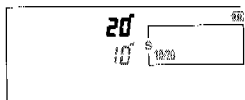

6-2-6 Distance unit setting

Select "m", "ft", or "ft-in" for the distance unit.

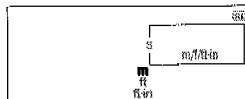

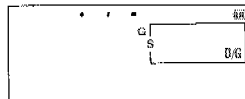

6-2-7 Angle unit setting

Select either "D" or "G" for the angle unit.



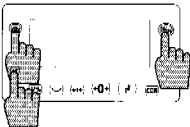
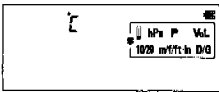

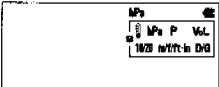

6-3 Entering the Mode for Initial Setting

Operating Procedures	Displays
<p>1</p>  <p>Press and release the (S) key while pressing the (←) key and the (→) key to turn on the power and open the initial settings screen.</p>	
<p>2</p>  <p>Press the (S) key to cause the desired setting item to flash.</p> <p>Pressing the (S) key once will cause the Pressure setting item "hPa" to flash.</p>	<p>Pressure unit setting screen</p> 

- The initial settings cannot be entered using the above operation when the power is on.
- When initial settings is entered, all of the items that can be set are shown in the display screen S box, the "hPa" of the "Temperature unit setting" flashes, and the current setting unit °C is displayed.

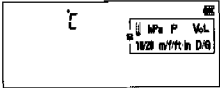
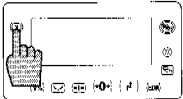
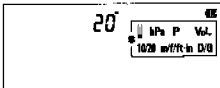
6-4 Changing an Initial Setting

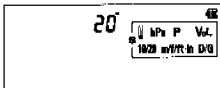
Following is an example for changing the initial settings, and the explanation is given using the operation procedure for "minimum angle display setting." Other items are set in the same manner, so refer to this explanation when setting them.

Operating Procedures	Displays
<p>1</p> <p>Follow the operation procedure for "Entering Initial Settings" on page 34 and enter "Initial Settings."</p>	
<p>2</p>  <p>Press the (S) key 4 times to cause the minimum angle display setting item "10/20" to flash.</p>	
<p>3</p>  <p>Press the (Δ) key or (▽) key to select "20" or "10" respectively.</p>	<p>When "20" is selected,</p>  <p>When "10" is selected,</p> 

Operating Procedures

4

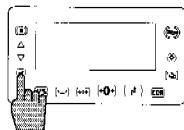

Press the  key to store the setting.
The version No. initial screen will be displayed,
and after a few seconds the vertical angle zero
setting screen will display $0-5E7^{\circ}$ "000".

Displays

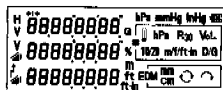
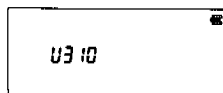

- The set minimum angle display will be stored even if the power is turned off.
- Above is the case where the angle unit is "DEG". If the unit is "GRAD", select either "50cc" or "20cc".

7. PREPARATION FOR SURVEYING

7-1 Centering and Leveling of the Instrument

7-1-1 Setting up the instrument and the tripod

- ① Adjust the tripod legs so that a height suitable for observation is obtained when the instrument is set on the tripod.
- ② Hang the plumb bob on the hook of the tripod, and coarse center over the station on the ground. At this time, set the tripod and fix the metal shoes firmly into the ground so that the tripod head is as level as possible, and the plumb bob coincides with the station on the ground.
- ③ If the tripod head is mis-leveled by the action of fixing the metal shoes into the ground, correct the level by extending or retracting each leg of the tripod.

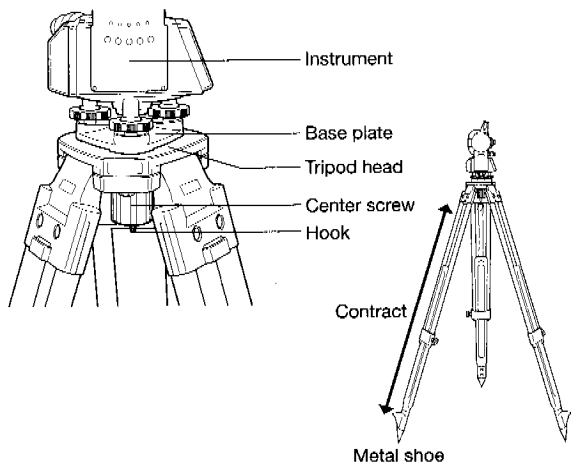

7-1-2 Centering and leveling with the optical plummet

- ① Look through the optical plummet eyepiece, and rotate the eyepiece knob until the center mark can be seen clearly.
- ② Rotate the focusing knob of the optical plummet and adjust the focus to the station on the ground.
- ③ Loosen the center screw of the tripod. Look through the optical plummet, and shift the instrument base on the tripod head, taking care to avoid rotating the instrument, until the center mark coincides with the station.
- ④ Adjust the tripod legs to position the bubble of the circular vial to the center. (Be sure not to put your foot on the metal shoe, which may disturb the position of the metal shoes.)

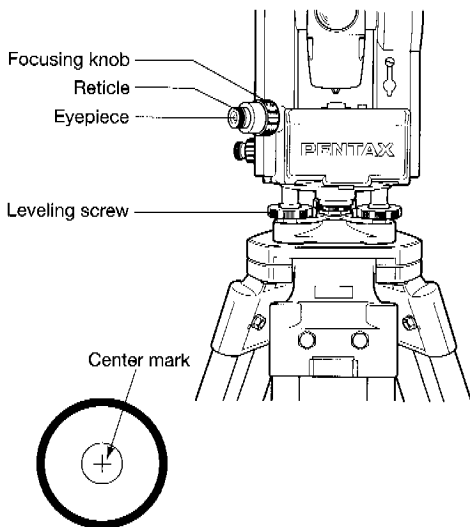

7-1-3 Leveling with plate vial

- ① Place a plate vial in parallel with a line joining any two of leveling screws. Adjust the two leveling screws. And position the bubble in the center of the vial. To adjust the screws at the same time, turn them in opposite directions.
- ② Adjust the remaining leveling screw so that the bubble in another plate vial comes to the center.
- ③ Be sure that the bubbles of both plate vials stay at the center. If not, repeat ① and ②.
- ④ Rotate the instrument 180° around the vertical axis, and check the bubbles stay unmoved.

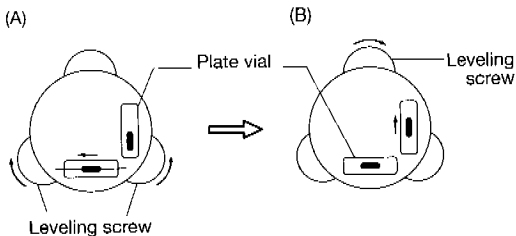

- The relationship between the leveling screw rotation direction and the bubble movement direction is shown by the arrow in Fig. A and Fig. B. The bubble moves in the direction of the left hand thumb movement or the opposite direction of the right hand thumb movement.
- If the bubble moves from the center in ④, the plate vial must be adjusted. Refer to plate vial "Inspection Adjustment" on page 42.

7-2 Eyepiece Adjustment and Aiming

7-2-1 Eyepiece adjustment

- ① Remove the telescope lens cap.
- ② Point the telescope at a bright object, and rotate the eyepiece ring full counter-clockwise.
- ③ Look through the eyepiece, and rotate the eyepiece ring clockwise until the reticle appears as its maximum sharpness.

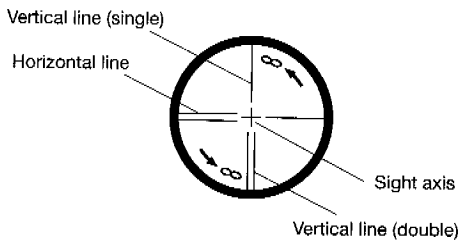

When looking into the eyepiece, avoid an intense look to prevent parallax and eye fatigue.

7-2-2 Object Aiming

- ① Point the telescope at the object by using the gunsight collimator.
- ② Look through the telescope eyepiece and finely adjust the focusing knob until the object is perfectly focused. If focusing is correct, the reticle will not move, in relation to the object, even when you move your eye slightly left and right.
- ③ Accurately align the reticle with the object, using each tangent screw.

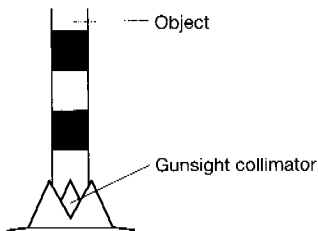

- Turn the focusing knob clockwise to focus on a near object. Turn the knob counterclockwise to focus on a far object.
- In ②, parallax may ruin the relation between the object and reticle, resulting in observation error.
- When aligning to an object by using the tangent screw, always align by rotating the screw clockwise. If the screw is turned past the object, turn it back to the original position and then turn the screw clockwise to align the reticle on the object.
- Even when vertical angle measurement is not required, it is recommended that the object be placed close to the center of the reticle.

8. INSPECTION AND ADJUSTMENT

8-1 Plate vial

<Inspection>

- ① Align the plate vial in parallel with a line joining any two of the leveling screws. Then, adjust the two screws to center the bubble in the vial.
- ② Adjust the remaining leveling screw to center the bubble of the other plate vial.
- ③ Repeat ① and ② to place the bubbles of both vials in the center.
- ④ Loosen the clamp screw and rotate the instrument 180° around the vertical axis.
- ⑤ No adjustment is necessary if the bubbles of the plate vials are in the center.

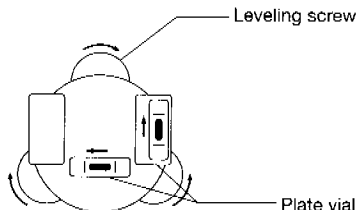

<Adjustment>

- ① If bubble of the plate vial moves from the center, bring it half way back to the center by adjusting the leveling screw which is parallel to the plate vial.
- ② Correct the remaining half by adjusting the bubble adjusting nuts with the adjusting pin.
- ③ Confirm that the bubble does not move from the center when the instrument is rotated by 180°.
- ④ When the bubble moves, start from ① once again.

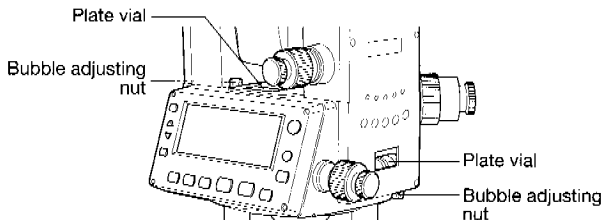

8-2 Circular vial

<Inspection>

After inspecting and adjusting the plate vials, no adjustment is necessary if the bubble is in the center of the circular plate vial.

<Adjustment>

If the bubble of the circular vial is not in the center, bring the bubble to the center by turning the bubble adjusting screws with an adjusting pin.

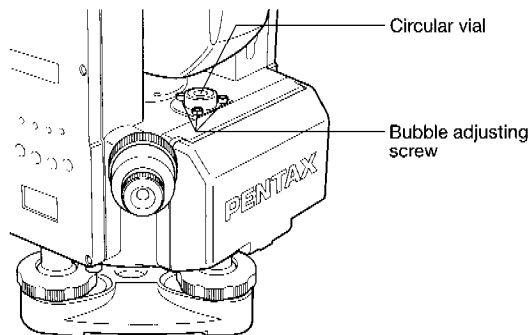

8-3 Inclination of Reticle

<Inspection>

- ① Set an object A on the line of sight through the telescope.
- ② Move Point A to the edge of the field of view by adjusting the telescope tangent screw (Point A').
- ③ No adjustment is necessary if Point A moves along the vertical line of the reticle.

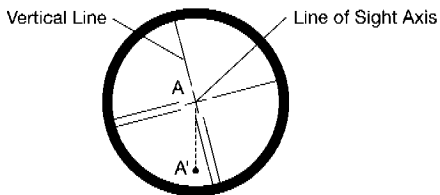

<Adjustment>

- ① If Point A is off from the vertical line of the reticle, first remove the eyepiece cover.
- ② Using the hexagonal wrench, loosen the four reticle adjusting screws slightly, loosening each screw evenly, and then rotate the reticle line around the sight axis and align the vertical line of the sight axis with Point A'.
- ③ Tighten the reticle adjusting screws again by the same amount, and repeat the inspection to make sure the adjustment is correct.

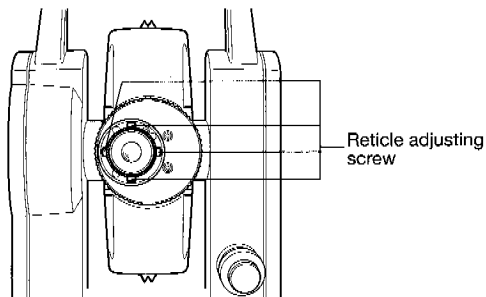

8-4 Perpendicularity of Line of sight to horizontal axis

<Inspection>

- ① Position a target Point A at a distance 30-50m away from the instrument, and sight it with the telescope.
- ② Loosen the telescope lock screw reverse the telescope on the vertical axis, until a point is sighted at a distance roughly equal to that of Point A. This is Point B.
- ③ With the telescope still reversed, loosen the horizontal lock screw, rotate the instrument around the vertical axis, and sight Point A again.
- ④ Loosen the telescope lock screw and reverse the telescope on the vertical axis, until a point is sighted at a distance equal to that of Point B. This is Point C. (Return the telescope to the normal position.)
- ⑤ No adjustment is necessary if Point B and C are aligned.

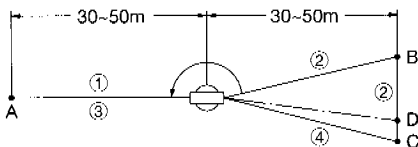

<Adjustment>

- ① If Points B and C are not aligned, mark Point D at 1/4 the length of the BC, from Point C in the direction of Point B.
- ② Using the hexagonal wrench, rotate the reticle adjustment screws horizontally opposite each other (see preceding page), and move the reticle to sight Point D.
- ③ Repeat the inspection and make sure the adjustment is correct.

8-5 Vertical 0 point error

Be sure to follow inspection procedures mentioned below after making adjustments on reticle and perpendicularity of line of sight to horizontal axis.

<Inspection>

- ① Set up the instrument and turn the power on.
- ② After vertical angle zero setting Press the  key to change to the Vertical angle/Slope distance/Vertical distance or Horizontal angle/Vertical angle/Slope distance combined display.
- ③ Sight the telescope at any reference target A. Obtain vertical angle (γ).
- ④ Reverse the telescope and rotate the alidade. Sight again at back state and obtain vertical angle θ .
- ⑤ If $\gamma + \theta = 360^\circ$, no further adjustment is necessary.

If the deviation ($\gamma + \theta - 360^\circ$) is wide, contact your local dealer.

8-6 Optical Plummet

<Inspection>

- ① Set the instrument on the tripod, and place a piece of white paper with a cross drawn on it right under the instrument.
- ② Look through the optical plummet, and move the paper so that the intersecting point of the cross comes to the center of the field of view.
- ③ Adjust the leveling screws so that the center mark of the optical plummet coincides with the intersecting point of the cross.
- ④ Rotate the instrument around the vertical axis. Look through the optical plummet each 90° of rotation, and observe the center mark position against the intersecting point of the cross.
- ⑤ If the center mark always coincides with the intersecting point, no adjustment is necessary.

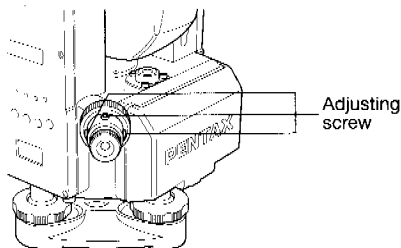
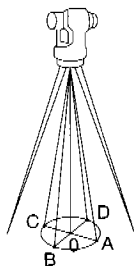

<Adjustment>

- ① If the center mark does not coincide with the intersecting point, rotate the optical plummet focusing knob cover counterclockwise and remove it.
- ② Mark the point set on the line of sight at each step of 90° on the white paper and call them A, B, C and D.
- ③ Join the opposed points (A, C and B, D) with a straight line, and set the intersecting point O.
- ④ Turn the four optical plummet adjusting screws with a hexagonal wrench so that the center mark coincides with the intersecting point O.
- ⑤ Repeat from ④, and check that adjustment is correct.

8-7 Offset Constant

The offset constant rarely changes. It is recommended, however, that inspection be done once or twice a year.

The inspection of the offset constant can be done on a certified base line. It can also be obtained in a simple way as described below.

< Inspection >

- ① Locate Points A, B and C at about 50m intervals on even ground.
- ② Set up the instrument at Point A, and measure the distances between \overline{AB} and \overline{AC} .
- ③ Set up the instrument at Point B, and measure the distance \overline{BC} .
- ④ Obtain the offset constant (K) :

$$K = \overline{AC} - (\overline{AB} + \overline{BC})$$

Contact your local dealer for adjustment of the offset constant when the K is not nearly 0.

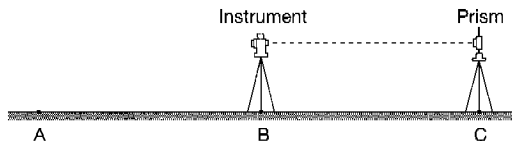
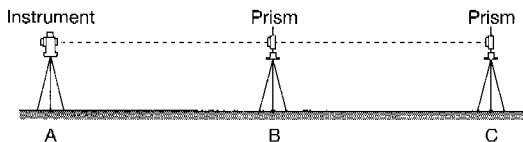

8-8 Beam axis and Line of sight

Be sure to check that the beam axis and line of sight are aligned when the adjustments on reticle and perpendicularity of line of sight to horizontal axis are made.

<Inspection>

- ① Set the prism at a distance greater than 50 m.
- ② Accurately aim the center of the prism through the telescope.
- ③ Turn the power on and press (MEAS) to measure.
- ④ No adjustment is necessary if beam receiving buzzer sounds immediately and measurement value is displayed in a few seconds.





- If instrument function is not as described in ④, contact your local dealer.
- This inspection should be done under good weather conditions.

Cautions on Inspection and adjustments

- ◇ Make all inspection and adjustments in numerical order.
- ◇ Be sure not to make inspection and adjustment on "Perpendicularity of line of sight to horizontal axis" prior to those on "Inclination of reticle". When making adjustments on "Inclination of reticle" and "Perpendicularity of line of sight to horizontal axis", be sure to make inspection on "Vertical 0 point error" and "Beam axis and line of sight".
- ◇ When adjustment is completed, be sure that adjusting screws are completely tightened. When finishing turning adjusting screws, be sure that screws are turned in a direction for tightening.
- ◇ Repeat inspection after adjustment, and check if the instrument has been adjusted properly.

9. APPENDIX

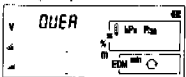
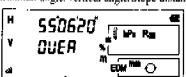
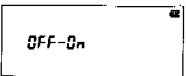
9-1 Error Messages

Message	Meaning	What to do
 <p>SPEED H-QUER</p>	Displayed when the telescope is turned too fast.	Press ←0→ key. Remeasure.
 <p>SPEED U-QUER</p>	Displayed when the telescope is turned too fast.	Turn the telescope up and down. Remeasure.
<p>Combined display Vertical angle/Slope distance/Vertical distance</p>  <p>QUER</p> <p>Combined screen Horizontal angle/Vertical angle/Slope distance</p>  <p>H 550620 V QUER</p>	The vertical angle exceeded $\pm 84^\circ$ during the V.Angle 0 Point display.	Turn the telescope up and down not to exceed $\pm 84^\circ$.
 <p>OFF-ON</p>	Some other problems in the instrument.	Turn the power off , and turn it on again.
 <p>E-88</p>		The instrument is out of order and requires repair.

9-2 Atmospheric Correction

The speed at which light travels through the air varies depending on the temperature and atmospheric pressure. The DistAngular is designed to measure distances at the speed of light. In order to measure accurately, atmospheric correction needs to be used. The instrument is designed to correct for weather conditions automatically if the temperature and pressure are input. Correction is then carried out based on the following formula.

Calculation formula

$$K = \left(279.75207 - \frac{79.55626 \cdot P}{273.14941 + t} \right) \times 10^{-6}$$

K: Atmospheric correction constant

P: Atmospheric pressure (hPa)

t: Temperature (°C)

Distance after atmospheric correction $D = D_s (1 + K)$

D_s : Measured distance when no atmospheric correction is used

9-3 hPa and mmHg Conversion Tables

Converting from hPa to mmHg

hPa	0	10	20	30	40	50	60	70	80	90
500	375 ^{mmHg}	383 ^{mmHg}	390 ^{mmHg}	398 ^{mmHg}	405 ^{mmHg}	413 ^{mmHg}	420 ^{mmHg}	428 ^{mmHg}	435 ^{mmHg}	443 ^{mmHg}
600	450	458	465	473	480	488	495	503	510	518
700	525	533	540	548	555	563	570	578	585	593
800	600	608	615	623	630	638	645	653	660	668
900	675	683	690	698	705	713	720	728	735	743
1000	750	758	765	773	780	788	795	803	810	818
1100	825	833	840	848	855	863	870	878	885	893
1200	900	908	915	923	930	938	945	953	960	968

Converting from mmHg to hPa

mmHg	0	10	20	30	40	50	60	70	80	90
400	533 ^{hPa}	547 ^{hPa}	560 ^{hPa}	573 ^{hPa}	587 ^{hPa}	600 ^{hPa}	613 ^{hPa}	627 ^{hPa}	640 ^{hPa}	653 ^{hPa}
500	667	680	693	707	720	733	747	760	773	787
600	800	813	827	840	853	867	880	893	907	920
700	933	947	960	973	987	1000	1013	1027	1040	1053
800	1067	1080	1093	1107	1120	1133	1147	1160	1173	1187
900	1200	1213	1227	1140	1153	1167	1180	1193	1207	1220

9-4 Deviation of distance when no atmospheric correction is made

When measurement is carried out with no atmospheric correction (with the settings fixed at a temperature of 15°C and an atmospheric pressure of 1013 hPa or 760mmHg), the deviation per 100 meters in temperature and pressure will be as shown in the tables below.

With hPa (15°C, 1013hPa as standard)

°C \ hPa	1200	1100	1013	900	800	700	600	500
45	2.0	-0.5	-2.6	-5.5	-8.0	-10.5	-13.0	-15.5
35	3.0	0.4	-1.8	-4.7	-7.3	-9.9	-12.5	-15.1
25	4.0	1.4	-0.9	-4.0	-6.6	-9.3	-12.0	-14.6
15	5.2	2.4	0.0	-3.1	-5.9	-8.6	-11.4	-14.2
5	6.3	3.5	1.0	-2.2	-5.1	-8.0	-10.8	-13.7
-5	7.6	4.7	2.1	-1.3	-4.2	-7.2	-10.2	-13.1
-15	9.0	5.9	3.2	-0.2	-3.3	-6.4	-9.5	-12.6

With mmHg (15°C, 760mmHg as standard)

°C \ mmHg	900	800	760	700	600	500	400
45	2.0	-1.3	-2.6	-4.6	-8.0	-11.3	-14.6
35	3.0	-0.4	-1.8	-3.9	-7.3	-10.8	-14.2
25	4.0	0.5	-0.9	-3.1	-6.6	-10.2	-13.7
15	5.2	1.5	0.0	-2.2	-5.9	-9.6	-13.3
5	6.3	2.5	1.0	-1.3	-5.1	-8.9	-12.7
-5	7.6	3.7	2.1	-0.3	-4.2	-8.2	-12.2
-15	9.0	4.9	3.2	0.8	-3.3	-7.4	-11.5

*When the actual pressure is 1013 hPa (760mmHg) and the temperature is 25°C, conducting the measurement with the temperature left at 15°C will result in the measurement being short by 0.9 mm per 100 meters.

9-5 Atmospheric Refraction and Earth Curvature

Correction

- Atmospheric refraction and earth curvature correction refers to correcting both the bending of the light beam caused by atmospheric refraction and the effect on the height differential and horizontal distance caused by the earth curvature.
- Correction called "atmospheric refraction and earth curvature correction" is initiated to correct deviation when the slope distance and vertical angle are used to determine the horizontal distance and the height differential. With this instrument, the following formula is used to correct these factors.
- Calculation formula when atmospheric refraction and earth curvature correction parameter is set to "ON":

Corrected horizontal distance (H)

$$H = S(\cos\alpha + \sin\alpha \cdot \frac{K-2}{2 Re} \cdot S \cdot \cos\alpha)$$

Corrected vertical distance (V)

$$H = S(\sin\alpha + \cos\alpha \cdot \frac{1-K}{2 Re} \cdot S \cdot \cos\alpha)$$

- Calculation formula when atmospheric refraction and earth curvature correction parameter is set to "OFF":

$$\begin{array}{l} \text{Horizontal distance } H' = S \cdot \cos\alpha \\ \text{Vertical distance } V' = S \cdot \sin\alpha \end{array}$$

S: Slope distance

α : Vertical angle from horizontal

K: Atmospheric refraction coefficient (0.14 or 0.2)

Re: Diameter of earth (6,370km)

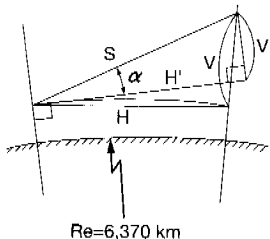

9-6 Distance Range

Generally speaking, the maximum range which can be measured varies considerably depending on the atmospheric conditions. For this reason, the performance tables on the following pages illustrate the values for both optimum and ordinary weather conditions.

It is extremely difficult to judge when weather conditions are "optimum" and when they are "ordinary". With this instrument, the conditions noted below are used to differentiate between the two situations. (Optimum weather conditions for surveying are different from ordinary weather conditions, and in surveying situations, cloudy skies are considered more favorable than sunny skies.)

Weather conditions for measurement ranges are based on the following standard values :

Normal	: Visibility of approximately 20km, with slight haze.
Good	: Visibility of approximately 40km, overcast, no heat haze and moderate wind.

10. SPECIFICATIONS

Telescope

Image	Erect
Magnification	24 ×
Effective aperture	30mm (EDM 30mm)
Resolving power	3.5"
Field of view	2.9% (1°38')
Minimum focus	1m

Distance measurement

Measurement range

1P	: *300m
	: **370m
3P	: *450m
	: **550m

*Normal conditions : 20km visibility with slight haze

**Good conditions : 40km visibility, overcast, no heat no haze and moderate wind

Accuracy $\pm(5+5\text{ppm} \times D)\text{mm}$
D : Distance

Minimum count

Normal	: 1mm
Track	: 10mm

Measuring time

Normal	: 2sec. (1mm)
Track	: 0.5sec. (10mm)

Measuring system Automatically repeated or one shot measurement

Maximum slope distance display 900.000m / 2952.755ft

Atmospheric correction

Temperature : °C/°F

Atmospheric Pressure : hPa / mmHg / inHg

Prism constant 0mm, -30mm

Atmospheric and earth curvature correction 0.2

Angle measurement

Measuring method Incremental rotary encoder

Detection method

Horizontal angle : Double

Vertical angle : Double

Minimum count 20"(50cc) / 10"(20cc)

Accuracy (DIN18723) 20" standard deviation

Measuring time 0.2"(Continuous)

Measuring mode

H : R / L , Hold, Retention (in Power OFF)

V : Zenith 0 / Horizontal 0, %, Compass

Display section

Display Segment type LCD

Number of characters 3 lines, 8characters w/back light

Sensitivity of vials

Plate vial 60" / 2mm

Circular vial 8" / 2mm

Optical plummet

Image Erect

Magnification 3 X

Focus range 0.5m~∞

Vertical axis. Tribrach type

Vertical axis Single

Tribrach Fixed

Data Output

Interface RS-232C

Baud rate 1200

Data bits 8bit

Parity bits None

Stop bits 1

Auto Power off

Setting up time 10min.

Ambient temperature

Working range -10°C~+50°C / 14°F~122°F

Tripod thread 5/8" × 11 (JIS / B)

Dimensions / Weight

Instrument 142(w) × 303(H) × 148(L)mm / 3.5kg

Carrying case 300(w) × 212(H) × 465(L)mm / 2.3kg

Battery pack BP01

Power source Lithium-ion

Output voltage DC7.2V

Operation time Continuous Approx. 2.5 hrs.

Weight Approx. 90g

Charger BC01(For North American use)/BC02(For European use)

Input voltage BC01:AC120V 60Hz, BC02:AC 240V 50Hz

Output voltage DC 6.3V

Charging time Approx. 100min

Weight Approx. 300g

PENTAX®

ASAHI PRECISION CO., LTD.

1-1-21, Shirako, Wako-shi,
Saitama-ken, 351-0101, Japan

Tel: +81-48-461-5377

Fax: +81-48-466-3979



The CE marking assures that
this product complies with
the requirements of the EC
directive for safety.

01.11.1999 First edition

TS00901E

Printed in Japan