

PENTAX®

ELECTRONIC THEODOLITE

ETH-105A/107/107C/110C/110F/120C/120F

INSTRUCTION MANUAL

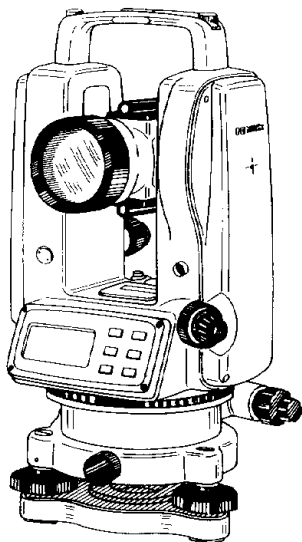

ASAHI PRECISION CO., LTD.

Safety Precautions (Must be Followed)

The following items are intended to prevent possible injury to the user or other people and/or damage to the instrument before it occurs. These safety precautions are important to the safe operation of this product and should be observed at all times.

■ Distinctive Displays

The following displays are used to distinguish precautions by the degree of injury or damage that may result if the precaution is ignored.



WARNING

Items indicated by this display are precautions which if ignored could result in death or serious injury.



CAUTION

Items indicated by this display are precautions which if ignored may result in injury or material damage.

*Here "injury" refers to injuries such as cuts, burns or electric shock the treatment of which will not likely require hospitalization or long-term attention.

**"Material damage" refers to damage to facilities, buildings, acquired data, etc.



WARNING

- Never look at the sun through the telescope as this may result in loss of sight. Always be sure to attach a reticule filter (SE2)
- Do not use at a place near flammable materials as there is a risk of explosion.



CAUTION

- Secure a handle to main unit with handle locking screws. Failure to properly secure the handle could result in the unit falling off while being carried, causing injury.
- Tighten the tribrach clamp knob securely. Failure to properly secure the handle could result in the unit falling off while being carried, causing injury.
- Do not use the carrying case as a footstool as it is slippery and unstable and may cause you to fall, resulting in possible injury.
- When mounting the instrument to the tripod, tighten the center screw securely. Failure to tighten the screw properly could result in the instrument falling off the tripod causing injury.
- Tighten securely the leg fixing screws of the tripod. A person could be injured by the extended tripod shoes due to loose screw.
- Do not carry a tripod with the metal shoes pointing toward another person as the person may be injured if they strike him or her.
- Make sure that your hands and feet are not in the vicinity of the tripod legs when installing the tripod, or a hand or foot stab would occur.
- Do not wield or throw the plumb bob, or a person could be injured if struck.

CONTENTS

1. Features	4
2. General	5
2.1 Precautions	5
2.2 Standard equipment	9
2.3 Nomenclature of parts	10
2.4 Unpacking and storing	12
2.5 Battery insertion	13
3. Key Operations and Display	14
3.1 Display	14
3.2 Keyboard	14
3.3 Function of each key	15
3.4 Other functions	22
(1) Quadrant indicating buzzer	22
(2) Remaining battery indicator	23
(3) Automatic power-off function	23
(4) Error codes	24
4. Preparation for Surveying	25
4.1 Leveling and centering	25
4.2 Eyepiece adjustment	31
4.3 Object sighting	32
5. Measurement	33
5.1 Angle measurement	33
(1) Horizontal angle measurement (right)	33
(2) Horizontal angle measurement (left)	33
(3) Vertical angle measurement	34
(4) Repeat angle measurement	34
5.2 Setting up	39
(1) Setting up the horizontal angle	39
(2) Setting up straight lines	40
(3) Setting up vertical lines	41
5.3 Stadia surveying	42

6. Function Selection by Special Key Operations	43
--	-----------

6.1 Selection of angle mode	43
-----------------------------------	----

6.2 Cancellation of automatic power-off function and selection of data-output parameters	44
---	----

7. Maintenance and Inspection	46
--	-----------

7.1 Maintenance	46
-----------------------	----

7.2 Inspection and adjustment	48
-------------------------------------	----

(1) Perpendicularity of plate vial to vertical axis	48
---	----

(2) Perpendicularity of circular vial to vertical axis	49
--	----

(3) Inclination of reticule pattern cross hairs	50
---	----

(4) Perpendicularity of line of sight to horizontal axis	51
--	----

(5) Vertical angle reading with line of sight horizontal	52
--	----

(6) Coincidence of line of sight of optical plummet with vertical axis	54
---	----

(7) Instructions on inspection and adjustment	55
---	----

8. Optional Accessories	56
--------------------------------------	-----------

9. Specifications	58
--------------------------------	-----------

1. Features

- Rotary encoder provides fast and accurate angle measurement, minimizing reading error. Measured angle is displayed on LCD panel.
- Horizontal angle, which is the most used measurement, is given priority display on the ETH series. Horizontal and vertical angles can be observed simultaneously on the two line LCD display panel.
- Display panel has a large and easy-to-read segment LCD. Simple, logical keyboard and mode display provide maximum operator convenience.
- Simple key operation provide 0 setting of horizontal angle at any position as well as clockwise and counter-clockwise readings. Buzzer sounds at every 90° (100g) for easy right angle setting.
- Vertical angle can be converted to percentage of slope by one touch of a key, very easy to check grade.
- AA dry batteries are used for power source. Being located in the standard, they can be easily replaced.
- Automatic power down prevents unnecessary battery discharge. The remaining battery capacity is indicated on the display to prevent the interruption of the work due to lack of capacity.
- Compact and light weight construction equipped with co-axial tangent screws provides easy operation.

2. General

2.1 Precautions

Storing and environmental conditions

- Avoid operation of the instrument under extremely high and low temperatures and do not subject the instrument to rapid temperature changes. (Refer to ambient temperature range specification.) Instrument may not operate properly when used at other than temperature range specified.

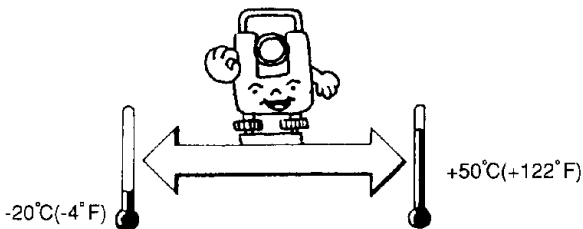

- Be sure to store instrument in the case. Avoid storing in a place which is subject to vibration, high humidity or dust.



- When storage and usage temperatures are widely different, leave the instrument in the case until it can adjust to the surrounding temperature.

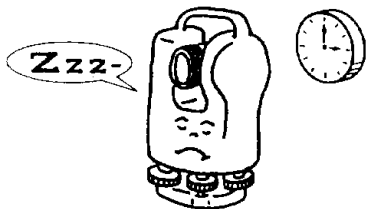

Transportation

- Do not subject to impact or vibration during transportation.

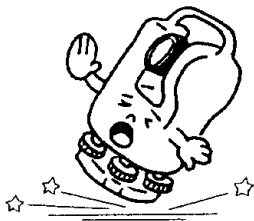

- Transport in carrying case. It is recommended that cushioning material be used around the case.

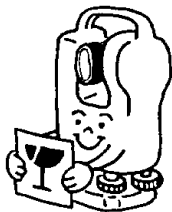

Others

- When not in use for extended periods or having been subjected to impact or vibration, be sure to check the instrument adjustments before starting a job.

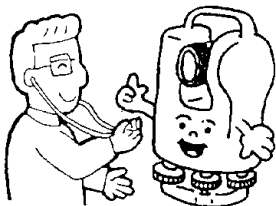

- If repair is necessary, contact your local dealer. Do not attempt to repair it by yourself.

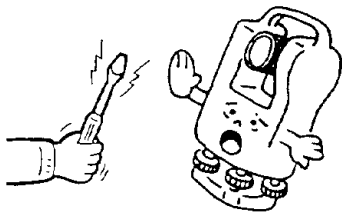

- To realise full capability of the instrument, adhere to cautions described in each chapter of this manual.

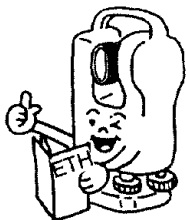

2.2 Standard equipment

- Body (with objective cap)1
- A set of Tool (with case).....1
(cleaning brush, 2 drivers, hexagonal wrench, 2 adjusting pins)
- A Set of Plumb Bob1
- Plumb Bob Hook (ETH-107C/110C only)1
- Silicone Cloth1
- Rain Cover1
- AA Dry Battery4
- Carrying Case1
- Instruction Manual1

*The attached AA batteries are the sample ones which were placed at factory shipment. Please prepare new batteries before operation because there is a risk of low battery due to the spontaneous discharge.

2.3 Nomenclature of parts

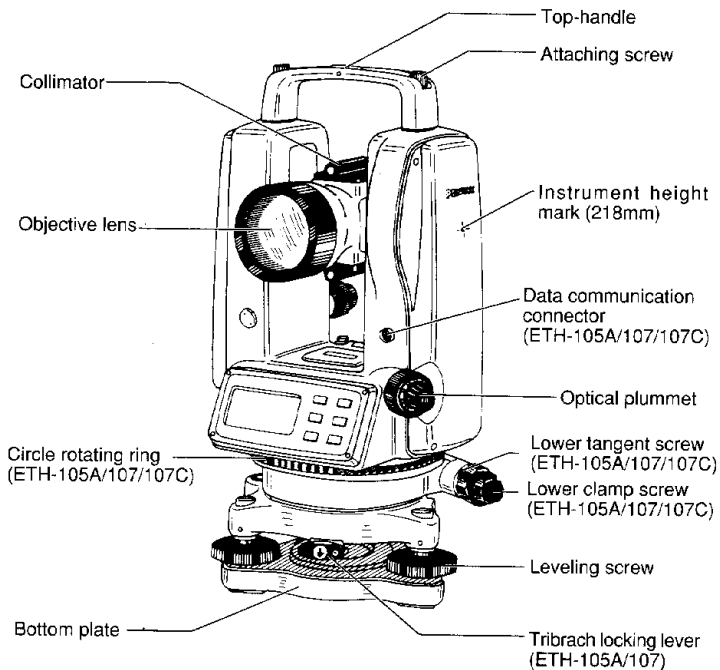

*Loosen a fixing screw on the lever when detaching a tribrach.

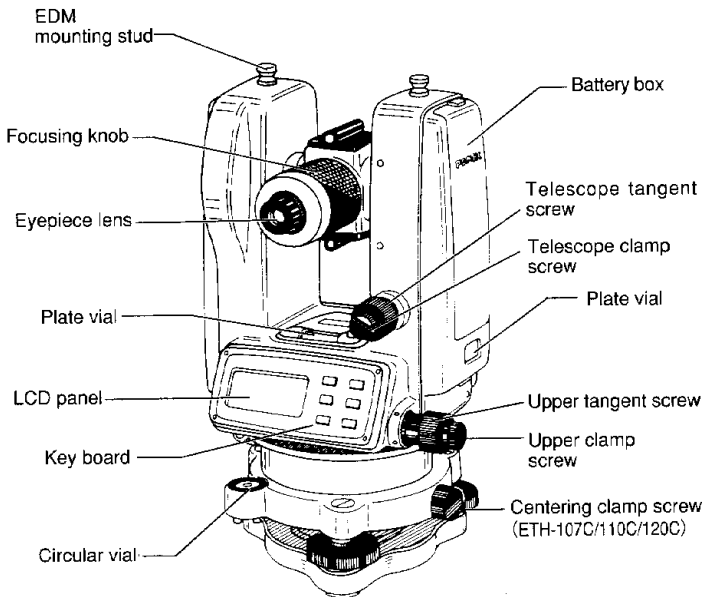

2.4 Unpacking and storing

Unpacking

- ① Gently set down the carrying case so that its cover is upward.
- ② Unlatch and open the case while pushing the latch lock (safety device).
- ③ Take the instrument out of the case.

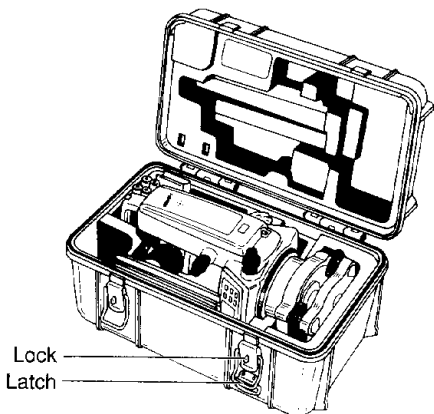

Storing

Store the instrument in the plastic case as follows.

- ① Set the telescope almost horizontal, and tighten the telescope clamp screw lightly.
- ② Align the yellow dots, and tighten upper clamp screw lightly.
- ③ Store the instrument correctly into the case with the yellow dots towards you.
- ④ Close the case lid and lock the clamp.

2.5 Battery insertion

- ① Take off the battery box, pressing the button on it.
- ② Place the batteries properly as indicated in the back of the cover, taking case of its polarity.
- ③ Put the button of the box into the slot on the standard cover, and press it until it clicks.

(ETH-105A)

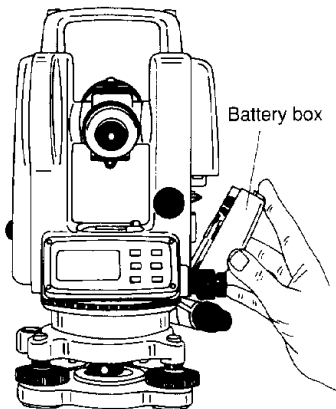

(ETH-107/107C/110C/110F/120C/120F)

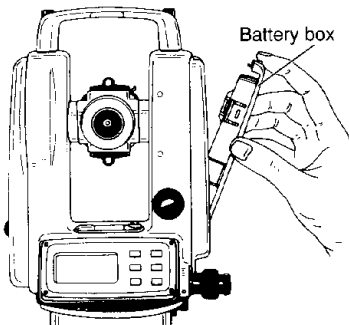

Caution

- Pay attention to the battery holder's (+) and (-) marks for proper battery insertion.
- Four 1.2V chargeable batteries (type AA) can also be used, but reliable high quality ones must be used.
- Batteries must be of the same type.
- Do not use a combination of batteries whose remaining capacity differs, or mix standard and rechargeable types.

3. Key Operations and Display

3.1 Display

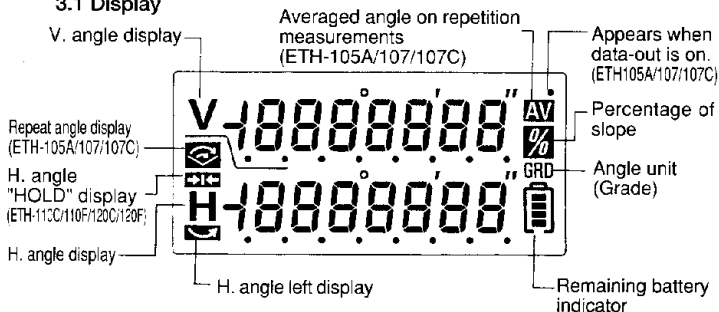

3.2 Keyboard

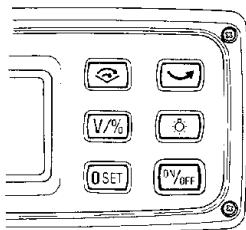

ETH-105A/107/107C

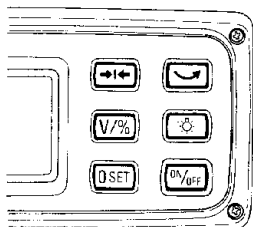

ETH-110C/110F/120C/120F



Power switch



H. Angle right/left



Illumination (Display panel and Reticule)



Repeat angle (ETH-105A/107/107C)



H. angle 0 set



H. angle "HOLD" (ETH-110C/110F/120C/120F)





V. angle/percentage of slope

3.3 Function of each key

(1) Power switch

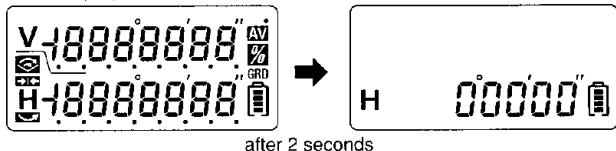
All the segments on the display light 2 seconds after turning the power on. Clockwise reading mode in horizontal angle is displayed.



Pressing  key displays the prompt to index the vertical angle zero point.

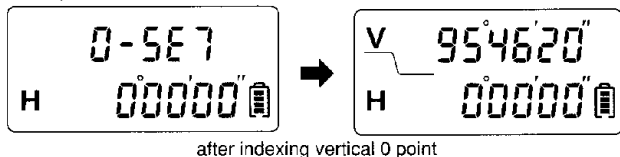

[Vertical angle 0 point indexing]

Turn the telescope upward from the depressed position to index the vertical 0 point. V/H mode will be displayed.

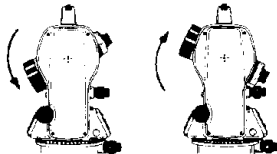

Rotate the telescope upward

■ When indexing the vertical circle, the zero point is detected as the telescope is rotated in elevation from slightly depressed.

(2) Selection of vertical angle/percentage of slope.

V/%

Vertical angle and percentage of slope is alternately displayed each time the key is pressed.

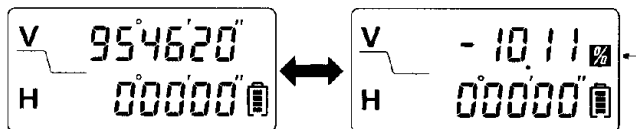

Indicates percentage of slope

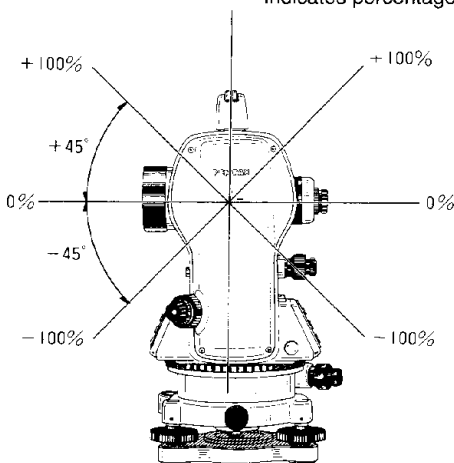

- In % graduation mode, when elevated or depressed angle of the telescope exceeds 45° (100% in display), error message [P OVER] is displayed.

(3) Horizontal angle 0 set key. **0SET**

Horizontal angle is set to $0^{\circ}00'00''$. This function is valid for both horizontal angle right and left. The function of this key is not valid for vertical angle.

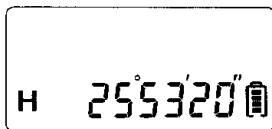

0SET is pressed. The buzzer will sound.



0SET is pressed again to set the horizontal angle to $0^{\circ}00'00''$ while buzzer is sounding.



■ To prevent accidental misoperation, 0 set key will not work unless it is pressed twice.

(4) Horizontal angle right/left key 

This key is used to select the angle reading mode of the horizontal angle, clockwise or counterclockwise (indicated with "" symbol). Clockwise or counterclockwise reading is alternately displayed each time the key is pressed.

This key will not work for the vertical angle.

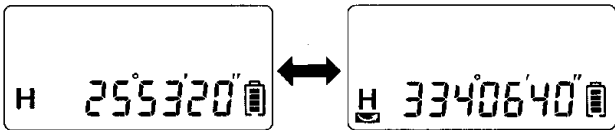

Indicates horizontal left

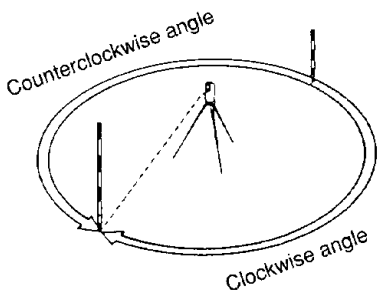

(5) Repeat angle measurement key  (ETH-105A/107/107C)

Pressing this key changes the horizontal angle measurement to repeat mode.

Accumulated value up to $\pm 1999^\circ$ ($\pm 1999g$) can be displayed.

Warning buzzer will sound when angle exceeds $\pm 1500^\circ$ ($\pm 1500g$)

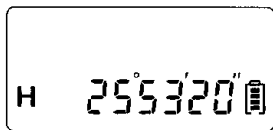

is pressed. The buzzer will sound.



is pressed again while the buzzer is sounding, to set the repeat angle measurement mode.

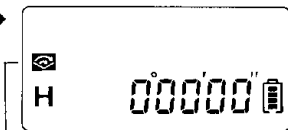
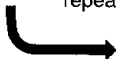



— indicates measurement on repetition mode

■ To cancel repeat measurement mode, press  twice.

(6) H. angle hold key  (ETH-110C/110F/120C/120F)

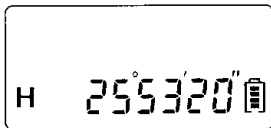
Horizontal angle value on display can be retained.



Press  The buzzer sounds.

Press  again while sounding to set "HOLD" mode.

indicates the retention
of H. angle

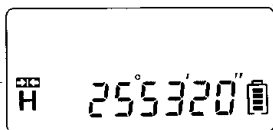

Horizontal angle value now remains unchanged when turning the instrument.

■ Press  twice to release "HOLD" mode.

(7) Illumination key



LCD panel and the reticule pattern are illuminated. The illumination is automatically turned off after one minute. Pressing key while on illumination immediately turns off the illumination.

■ Use the reticule illumination lever to adjust the brightness of illumination of the reticule.

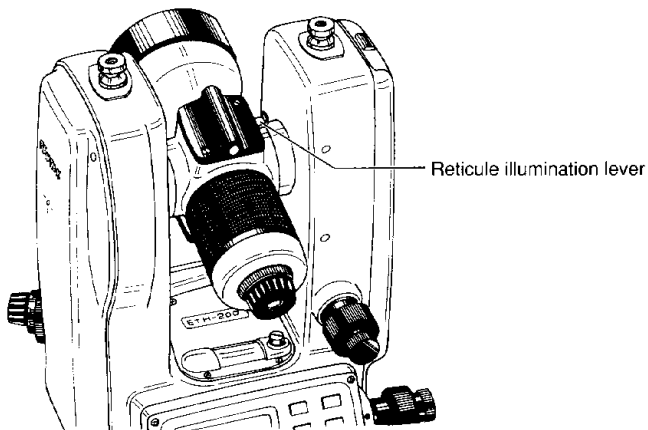

3.4 Other functions

(1) Quadrant indicating buzzer

In horizontal angle measurement, the buzzer sounds when the reading passes any of 0° , 90° , 180° , and 270° .

The buzzer starts sounding where the angle is $\pm 1'$ to respective value, and stops sounding where the angle is within $\pm 20''$ from the respective value.



Buzzer sounds



Buzzer stops

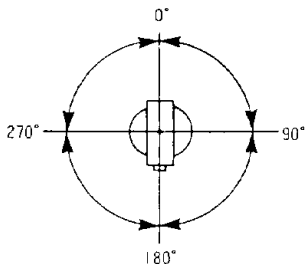

■ Buzzer can be canceled if not necessary. (Refer to page 43).

(2) Remaining battery indicator

The status of the remaining battery capacity is displayed on the bottom right on the display with “” symbolizing the battery.

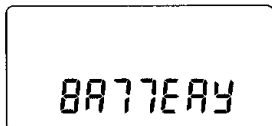
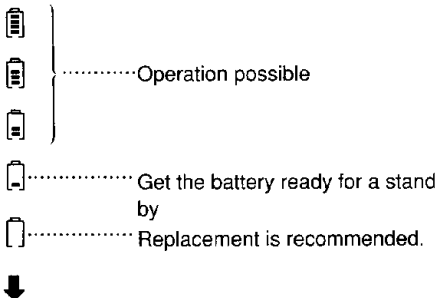

..... "BATTERY" will disappear 5 seconds after it is displayed. Replace the batteries.

(3) Automatic power-off function

No operation on the instrument for about 20 minutes makes the power automatically turn off to prevent unnecessary battery discharge.

- With the auto power off being effective, the power automatically turns off when neither key operation nor turning the angles horizontally and vertically more than 1° is done for about 20 minutes.

- Auto-power off function can be canceled if not necessary. (Refer to page 44, 45).

(4) Error codes

Displayed code	Meaning	What to do
C-OVER (ETH-105A only)	Displayed when the instrument is tilted out of compensation range. (The message may appear when the instrument is turned too quickly.)	Relevel the instrument. If the error message still appear, repair is required.
U-OVER	Displayed when the telescope is turned too quickly (faster than 4 revolutions/second).	Turn the telescope to index vertical 0 point again.
H-OVER	Displayed when the alidade is turned too quickly horizontally (faster than 4 revolutions/second).	Press [OSET] and remeasure from the start.
OVER	Displayed when the angle sum exceeds the allowable range (approx. 2000°) in the REPEAT mode.	Press [OSET] and remeasure from the start.
AU ERR	Displayed when the averaged value in repeat mode differs more than 60" from any of previously measured values.	Press [OSET] and remeasure from the start.
E-16	Some problem found in the instrument. "E-00" is displayed.	Turn the power off and then on again. If the error message still appears, repair is required.

4. Preparation for Surveying

4.1 Leveling and centering

(1) When coarse centering using a plumb bob is performed.

1 Setting up the instrument and the tripod

① Adjust the tripod legs so that a height suitable for surveying is obtained when the instrument is set on the tripod.

[For ETH-105A/107/110F/120F]

② Hang the plumb bob on the hook of the tripod, and carry out coarse centering to the station on the ground. At this time, set the tripod and fix the metal shoe firmly into the ground so that the tripod head is as level as possible, the center screw is at the center of its moving range, and the plumb bob coincides with the station on the ground.

③ If the tripod head is disturbed by the action of fixing the metal shoe into the ground, correct the level by extending or retracting each leg of the tripod.

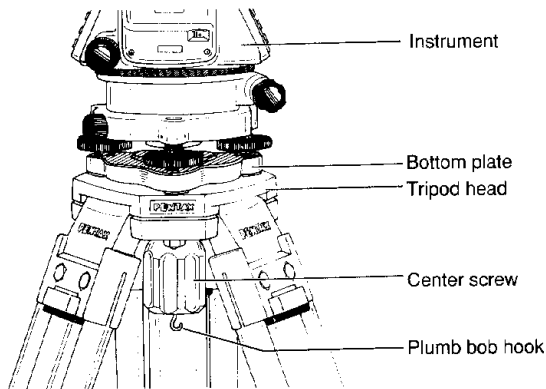

[For ETH-107C/110C/120C]

- ② Set the theodolite on the tripod head. Screw the center screw into the tripod clamp screw of the theodolite, finger tight.
- ③ Fix the shifting device after setting it to almost the center of the shifting range.
- ④ Pass the plumb bob hook through the hole in the center screw, and hang it on the ring located at the center of the theodolite lower end. Adjust the length of the string so that the tip of the plumb bob is close to the station center.
- ⑤ Move the theodolite by pushing the bottom plate with the fingertips. When the tip of the plumb bob coincides with the station, tighten the center screw securely.

2 Leveling with the circular vial

- ① By adjusting any two leveling screws, position the bubble in the center of the vial (see (A)). (To adjust the screws at the same time, turn them in opposite directions).
- ② Adjust the remaining leveling screws, and position the bubble in the center of the circle (See (B)).

For the relation between the screw adjusting direction and bubble moving direction, see the arrow marks in (A) and (B). Bubble moves in the same direction of the movement of a thumb on the left hand or in the opposite direction on the right hand.

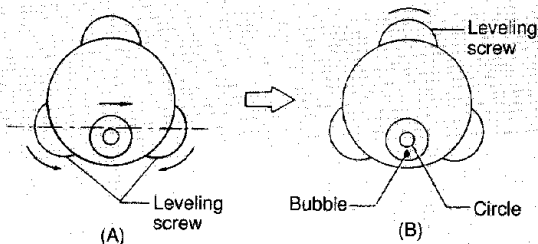

3 Leveling with the plate vials

- ① Place the plate vial in parallel with a line joining any two of the leveling screws. Adjust the two screws, and position the bubble in the center of the level (A). (To adjust the screws at the same time, turn them in opposite directions.)

[ETH-105A]

- ② Rotate the plate vial through 90° around the vertical axis. Adjust the remaining leveling screw so that the bubble comes to the center of plate vial.
- ③ Repeat ① and ② by rotating the plate vial through 90° so that the bubble is positioned in the center when the plate vial is moved in any direction.

[ETH-107/107C/110C/110F/120C/120F]

- ② Adjust the remaining leveling screw so that the bubble in another plate vial comes to the center.
- ③ Be sure that the bubbles of both plate vials stay at the center. If not, repeat ① and ②.
- ④ Rotate the instrument 180° around the vertical axis, and check the bubbles stay unmoved.

- See arrows in Fig. below for the relation between the direction of leveling screw rotation and the bubble shifting direction.
- If the bubble is not positioned stable. "Adjustment of the plate vial" is necessary.

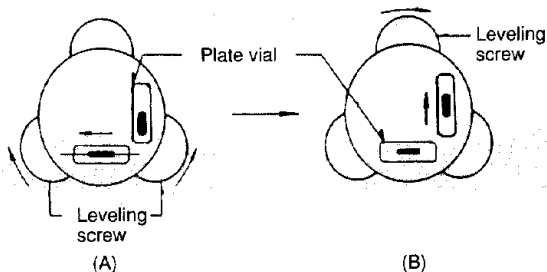

4 Centering with the optical plummet

After ①, and ② and ③ are completed, center correctly in the following manner using optical plummet.

- ① First remove the plumb bob. Look through the optical plummet eyepiece, and rotate the eyepiece knob until the center mark can be seen clearly.
- ② Rotate the focusing knob of the optical plummet and adjust the focus to the station on the ground.

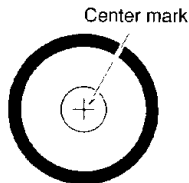
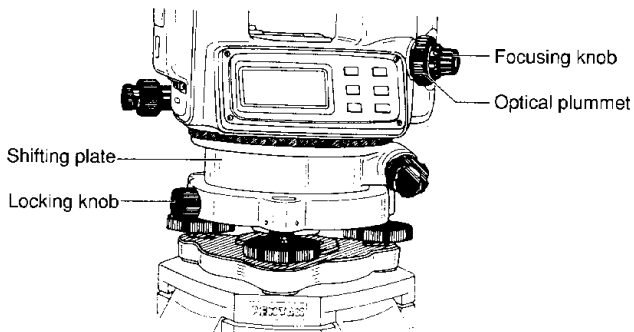

[ETH-107C/110C/120C]

- ③ Loosen the shifting plate locking knob. Look through the optical plummet eyepiece, and push the alidade with the fingertips so that the center mark coincides with the station.
- ④ Tighten the shifting plate locking knob. Ascertain that the bubble stays positioned in the center when rotating the plate vial position in steps of 90° . If the bubble is not positioned in the center, adjust the leveling screw.

[ETH-105A/107/110F/120F]

- ③ Loosen the center screw of the tripod. Look through the optical plummet, and move the bottom plate on the tripod head taking care to avoid rotating the instrument until the center mark coincides with the station.
 - ④ Ascertain that the bubble stays positioned in the center when rotating the plate vial position in steps of 90° . If the bubble is not positioned in the center, adjust the leveling screw.
- The focusing device permits focusing from 0.5m to ∞ with the optical plummet.
 - Even if the bubble is shifted by one graduation in ④, deviation of centering is just 0.2mm at the instrument height of 1.4m, giving little effect on survey result.

(2) When coarse centering using a plumb bob is not performed

1 Setting up the instrument and tripod

- ① Adjust the tripod so that a height suitable for surveying is obtained with enough extension/contraction margin left when the instrument is set on the tripod. Observing the station, extend the tripod legs and fix the metal shoe firmly into the ground so that the tripod center is positioned almost right above the station.
- ② Set the instrument on the tripod head.

2 Centering and leveling with the optical plummet

- ① Look through the optical plummet eyepiece, and rotate the eyepiece until the center mark can be clearly seen.
- ② Rotate the focusing knob of the optical plummet and focus on the station.
- ③ Looking through the optical plummet, rotate the three leveling screws to tilt the instrument so that the center mark coincides with the station.
- ④ Adjust the length of each tripod leg by extending or contracting it, and position the bubble of the circular vial in the center of the circle. (When doing this, place a foot on the metal shoe of the tripod to hold it in that position.)

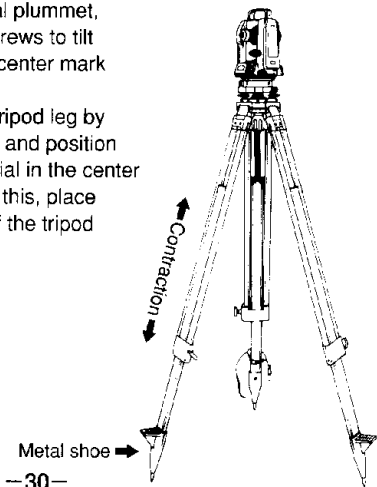



3 Leveling with the plate vials

- ① Level the instrument as indicated in ③ "Leveling with the plate vials" on Page 27.
- ② After leveling the instrument, re-adjust the center by moving the instrument on the tripod head if necessary.

4.2 Eyepiece adjustment

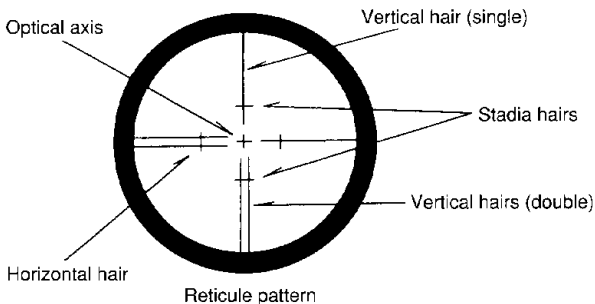
- ① Remove the telescope lens cap.
- ② Point the telescope at a bright object, and rotate the eyepiece ring full counterclockwise.
- ③ Look through the eyepiece, and rotate the eyepiece ring clockwise until the reticule appears as its maximum sharpness.



- When looking into the eyepiece, avoid intense look to prevent the parallax and eye fatigue.
- When it is hard to see the cross hairs due to poor brightness, press  to illuminate it. Density of brightness can be adjusted by a reticule illumination lever.

4.3 Object sighting

- ① Point the telescope at the object using the collimator sight. Tighten all clamp screws.
- ② Look through the telescope eyepiece and finely adjust the focusing knob until the object is perfectly focused. If focusing is correct, the cross hairs will not move in relationship to the object when you move your eye slightly left and right while looking through the eyepiece. This will eliminate any parallax.
- ③ Accurately align the cross hairs with the object, using each tangent screw.

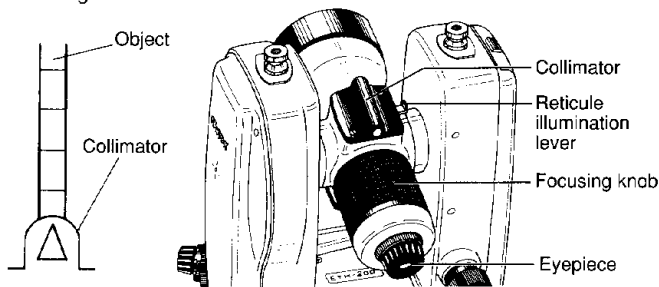

- Turn the focusing knob clockwise to focus on a near object. Turn the knob counterclockwise to focus on a far object.
- In ②, parallax may ruin the relation between the object and cross lines, resulting in the survey error.
- When aligning to an object using the tangent screw, always align by rotating the screw clockwise. If the screw is turned past the object, turn it counterclockwise to the original position and then turn the screw clockwise to align the cross hair on the object.
- Even when vertical angle measurement is not required, it is recommended that the object in the reticule pattern be placed as close as to the center of the reticule pattern and that the bold object be placed between two vertical lines on the reticule pattern.

5. Measurement

5.1 Angle measurement

(1) Horizontal angle measurement (right)

- ① Level the instrument, and turn the power on.
- ② Sight the first object using the upper clamp and tangent screws as well as the telescope clamp and tangent screws.

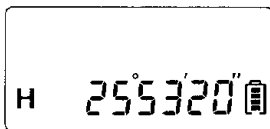

- ③ Press **0SET**. While the buzzer is sounding continuously, press **0SET** again to set the horizontal angle to $0^{\circ}00'00''$.



- ④ Collimate the second object using the upper clamp and tangent screws as well as the telescope clamp and tangent screws.
- ⑤ Read the displayed value (α).

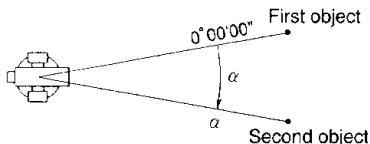
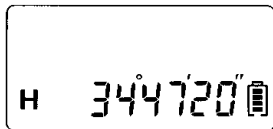

Horizontal angle (α) = $34^{\circ}47'20''$

(2) Horizontal angle measurement (left)

- ① Press  after turning the power on.

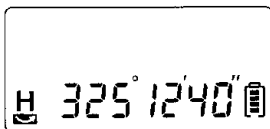

Horizontal angle measurement switches from horizontal right to horizontal left.  symbol will appear for the indication.

- ② Subsequent operation will be done as in (1) Horizontal angle measurement (right), except that the order of collimation is reversed.

■ To switch the mode back to "right", press  again.

(3) Vertical angle measurement

- ① Set up the instrument over the station point. Level it and turn the power ON.
② Press  to set to vertical angle mode.

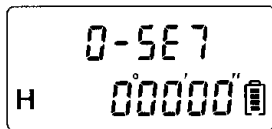

- ③ Turn the telescope to index the vertical 0 point. (Refer to page 15)

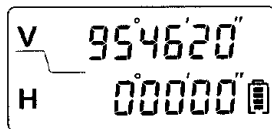

- ④ Sight the object A using the upper clamp and tangent screws as well as the telescope clamp and tangent screws.
- ⑤ Vertical angle (θ) is displayed.

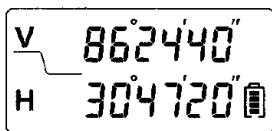

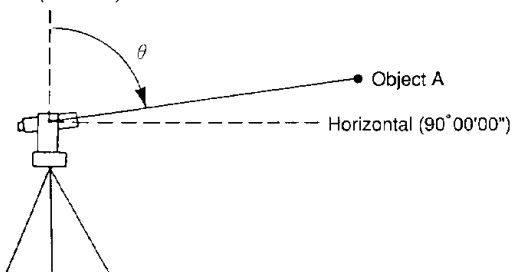

Vertical angle (θ) = 86°24'40"

Zenith (0°00'00")



■ Factory setting is Zenith 0° as shown above.

(4) Repeat angle measurement (ETH-105A/107/107C)

- ① Press , and press it again while sounding. Repeat angle measurement mode is set and the symbol  is displayed.



- ② Collimate the first object.

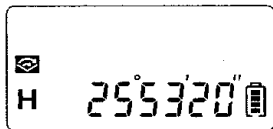

- ③ Press  to set angle to zero.



- ④ Collimate the second object using the upper horizontal clamp/tangent screw and the telescope clamp/tangent screw.

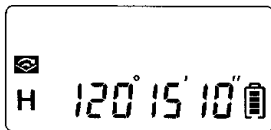

- ⑤ Press  to store, in memory, the horizontal angle to the second object.

Current number of repetitions and then averaged angle is displayed after about one second.

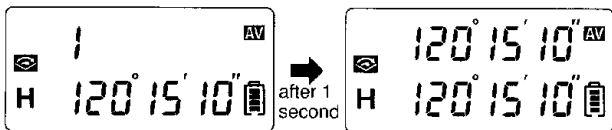

- ⑥ Collimate the first object using the lower clamp and tangent screws as well as telescope clamp and tangent screws.

■ Do not disturb the upper clamp knob and upper tangent screw.

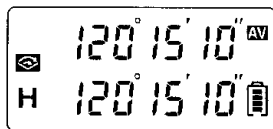

- ⑦ Recollimate the second object using the upper clamp and tangent screws, as well as telescope clamp and tangent screws.

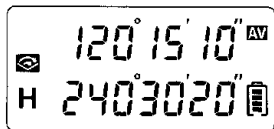

⑧ Press



(Completion of duplicate measurements.)

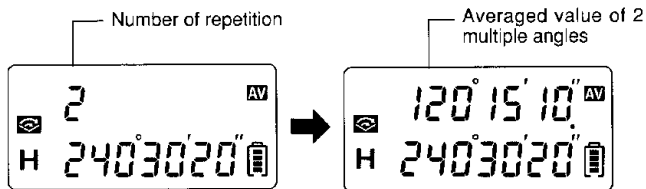

⑨ Repeat ⑥ ⑦ ⑧ to get the multiple angles of desired number of repetition.

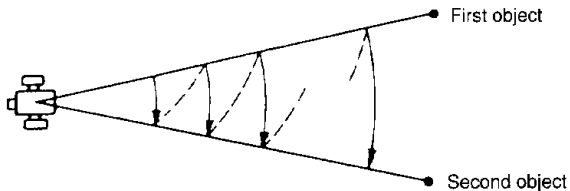

■ The averaged angle of up to 9 times repetition can be obtained. The buzzer sounds for 9th repetition.

5.2 Setting up

(1) Setting up the horizontal angle

Setting up a specific angle (Ex: 90°) from a reference point in civil engineering and other work:

- ① Point the telescope to the reference point accurately, and set the horizontal angle at 0° by pressing the 0 set key.

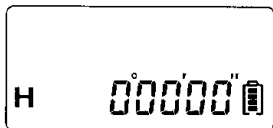

- ② Loosen the upper clamp knob, and rotate the instrument around the vertical axis. Tighten the clamp knob when the displayed number comes close to the specific angle.
- ③ Operate the upper tangent screw, and precisely set the displayed number to the specific angle.



- ④ The point the telescope is aiming is marked and becomes a setting up point.

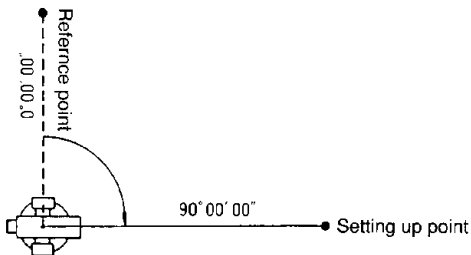

(2) Setting up straight lines

A line joining points collimated to an object, near or distant, is a straight line. This fact is used in setting up straight lines. Setting up a point C on the extension of the straight line AB is carried out as follows.

- ① Set up the instrument at point B on the straight line and level it. Then, sight point A.
- ② Loosen the telescope clamp screw and reverse the telescope about its horizontal axis. Set a point on the line of sight and call it point C₁.

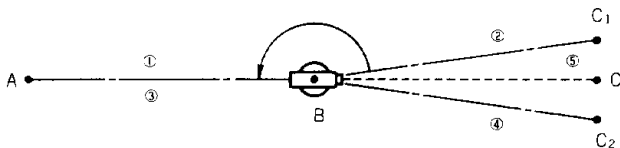

- ③ Loosen the upper clamp screw and rotate the instrument about its vertical axis and sight on point A again.
- ④ Loosen the telescope clamp screw and reverse telescope on its horizontal axis again. Set a point on the line of sight and call it point C₂.
- ⑤ Set point C in the center of points C₁ and C₂. This point B and C is an extension of the straight line AB.

■ When extending the straight line in a rather long distance, repeat the extension of the straight line in a way that distance of AB and BC is limited up to about 100m, respectively.

(3) Setting up vertical lines

When the instrument is leveled and the telescope is rotated about its horizontal axis, the line of sight generates a vertical plane, and a vertical line can thus be set up. Setting up a point B on the perpendicular at point A is carried out as follows.

- ① Set the instrument on a point P at a distance equal to or longer than AB. Level the instrument and sight point A.
- ② Loosen the telescope clamp screw. Point the telescope upward at the same angle as point B and set a point on the line (point B₁).
- ③ Move the instrument to point which is at right angles to line AP and at the same distance as AP from point A. Level the instrument and sight point A.

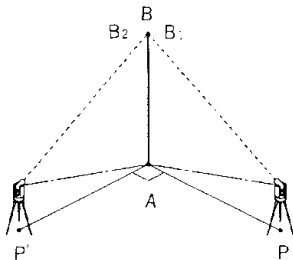

- ④ Loosen the telescope clamp screw, and point the telescope upward at the same angle as point B and set a point on the line (point B₂).
- ⑤ Set the point B at the crossing point of the extended lines of B₁ and B₂. The line joining A and B is perpendicular.

- When sighting point A in procedures ① and ③, be sure that the bubble is in the center of the plate vial.
- When more precise results are required, repeat ① ② and ③ ④ respectively using the telescope in the normal and reverse positions. And set B1 and B2 at the centers of the points obtained using the telescope in the normal and reverse positions.
- The telescope normal position means the state where the vertical circle is positioned on the left of the telescope eyepiece. The reverse position is the state where the vertical circle is positioned on the right of the eyepiece.

5.3 Stadia surveying

The stadia hairs on the reticle provide the method of measuring distance and height from the instrument center to a leveling rod.

- Calculations are easy since the stadia constant is 0.

When the line of sight is inclined

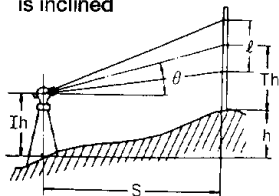

$$S = 100 \ell \cos^2 \theta$$

$$h = 50 \ell \sin 2\theta$$

When the line of sight is horizontal

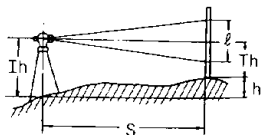

$$S = 100 \ell$$

$$h = I_h - T_h$$



S: Horizontal distance
 h: Difference in elevation
 θ : Vertical angle

ℓ : Difference in top and bottom stadia hair readings
 I_h : Instrument height
 T_h : Line of sight reading

6 Function Selection by Special Key Operations

Special key operation enables selection of angle unit and other such items.



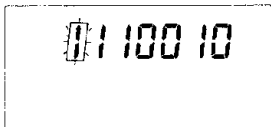

6.1 Selection of angle mode

- ① While pressing  for ETH-105A/107/107C ( for ETH-110C/110F/120C/120F), also press  to turn the power ON.



Normal factory settings

■ Modes currently set are displayed with left figure blinking.

- ② Use  and  for ETH-105A/107/107C ( and  for ETH-110C/110F/120C/120F) to set desired modes.

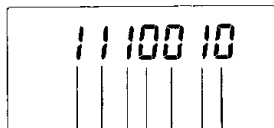

1: Compass graduation	0: Void
1: Zenith 0°	0: Horizontal 0°
1: Mil	0: Void
1: Decimal	0: Void
1: Degree	0: Grade
1: 90° Buzzer ON	0: OFF
(ETH-105A/107/107C) 1: 10" Display	0: 5" Display
(ETH-110C/110F/120C/120F) 1: 20" Display	0: 10" Display



(for ETH-105A/107/107C)



(for ETH-110C/110F/120C/120F)

: To change the figure on blink from "0" to "1" or vice versa.



: To shift the blinking cursor toward the right. (Cursor returns to the left figure after being shifted completely to the right.)

- ③ Press **0SET** to store the settings in memory. (Completion of settings.)

Settings are displayed for 1 second and the instrument returns to normal operation.

■ When different graduation units are set simultaneously, precedence is given in the following order.

- ① Mil ② Decimal ③ Degree/Grad

■ For setting angle unit in either Degree or Grade, set both 4th and fifth digits from the left to 0.

■ When vertical compass graduation is selected, the selection of Zenith 0°/Horizontal 0° is disabled.

■ Modes are stored in memory even when the power is turned off or batteries changed.



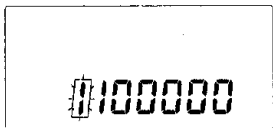

6.2 Cancellation of automatic power-off and selection of data-out .

- ① While pressing **V/0%**, press **ON/OFF** to turn the power ON.





Normal Factory settings

■ Current setting is displayed with a left figure blinking.

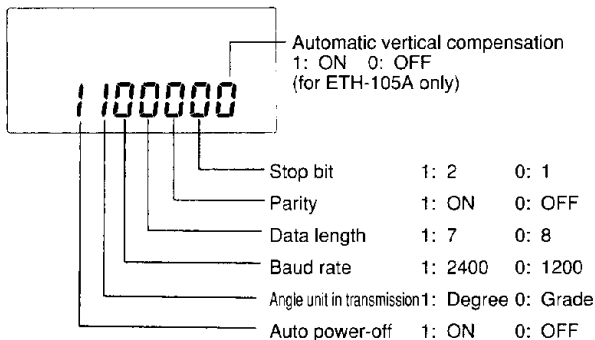
- ② Use  and  for ETH-105A/107/107C () and  for ETH-110C/110F/120C/120F) to set desired modes.



-  (ETH-105A/107/107C) }
 (ETH-110C/110F/120C/120F) } : To change the figure on blink from "0" to "1" or vice versa.

-  : To shift the **blinking cursor toward the right**. (Cursor returns to the left figure after being shifted completely to the right.)

- ③ Press  to store the settings in memory. (Completion of settings.)

Settings are displayed for 1 second and the instrument returns to normal operation.

- Settings are stored in memory even when the power is turned off or battery changed.

7. Maintenance and Inspection

7.1 Maintenance

Stain on the main body

- ① Brush dust off and wipe off moisture with tissue paper.
- ② Clean off any stains with a soft, dry cloth.
- ③ Excessive stains should be removed with a soft cloth soaked in a water-diluted neutral detergent and squeezed dry.

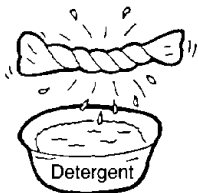

Stains on the lens surface

- ① First, brush dust off.
- ② Gently wipe off stains with a silicone cloth or a cleaning cloth for eye glass lenses.
- ③ Excessive stains should be wiped off with soft cotton cloth impregnated with a cleaning liquid for eye glass lenses.

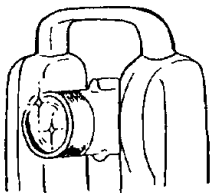

Handling the battery

If the instrument is not to be used for a long period of time, be sure to remove the batteries from the instrument, and then store it.

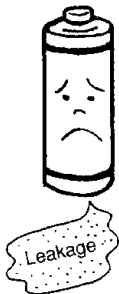

Note:

- Be sure not to use such chemicals as benzene, thinner or gasoline.
- Be careful not to scratch the lens surface.
- Leaving the batteries in the instrument for extended period may cause power consumption even if it is not in use.
- If used batteries are left in the instrument, it may be damaged by the battery fluid leakage.

7.2 Inspection and adjustment

(1) Perpendicularity of plate vial to vertical axis

1 Inspection

- ① Align the plate vial in parallel with a line joining any two of the leveling screws. Then, adjust the two screws to center the bubble in the vial.

[ETH-105A]

- ② Rotate the plate vial through 90° around the vertical axis. Adjust the remaining leveling screw to bring the bubble to the center. (Be sure not to operate 2 leveling screws adjusted in ①.)
- ③ Rotate the plate vial through 180° around the vertical axis.
- ④ No adjustment is necessary if the bubble of the plate vial is in the center.

[ETH-107/107C/110C/110F/120C/120F]

- ② Adjust the remaining leveling screw to center the bubble of the other plate vial.
- ③ Repeat ① and ② to place the bubbles of both vials in the center.
- ④ Loosen the upper clamp screw and rotate the instrument 180° around the vertical axis.
- ⑤ No adjustment is necessary if the bubbles of the plate vials are in the center.

2 Adjustment

- ① If bubble of the plate vial moves from the center, bring it half way back to the center by adjusting the leveling screw which is parallel to the plate vial.
- ② Correct the remaining half by adjusting the bubble adjusting nuts with the adjusting pin.
- ③ Confirm that the bubble does not move from the center when the instrument is rotated by 180° .
- ④ When the bubble moves, start from ① once again.

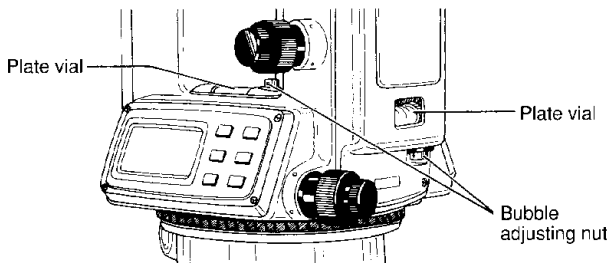

(2) Perpendicularity of circular vial to vertical axis

1 Inspection

No adjustment is necessary if the bubble of the circular vial is in the center after inspection and adjustment of "Perpendicularity of the Plate Vial to the Vertical Axis".

2 Adjustment

If the bubble of the circular vial is not in the center, bring the bubble to the center by turning the bubble adjusting screw with the adjusting pin.

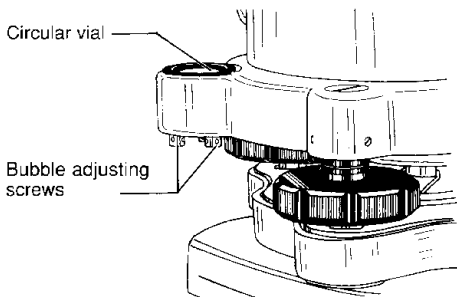

(3) Inclination of reticule pattern cross hairs

1 Inspection

- ① Set an object point A on the line of sight through the telescope.
- ② Move point A to the edge of the field of view by adjusting the telescope tangent screw (point A').
- ③ No adjustment is necessary if point A moves along the vertical line of the reticule.

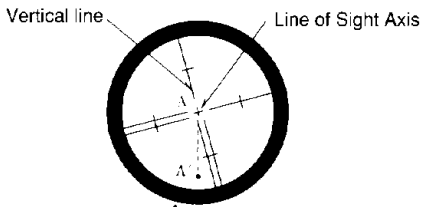

2 Adjustment

- ① If the point A does not move along the vertical line, first remove the eyepiece cover.
- ② Loosen the four cross hair adjusting screws uniformly with the adjusting pin. Rotate the cross hair around the sight axis, and align the vertical line of the cross hairs with point A'.
- ③ Tighten the cross hairs adjusting screws uniformly. Repeat the inspection and check that the adjustment is correct.

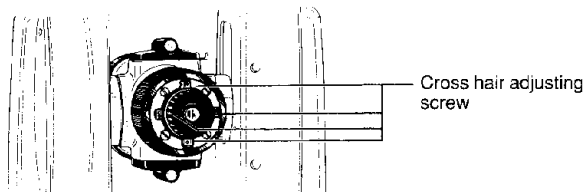

(4) Perpendicularity of line of sight to horizontal axis

1 Inspection

- ① Set an object point A at a distance of 30 to 50m away from the instrument, and sight it through the telescope.
- ② Loosen the telescope clamp screw and reverse the telescope around the horizontal axis. Mark a point set on the line of sight at about the same distance to the object point A, and call it point B.
- ③ Loosen the upper clamp screw, and rotate the instrument around the vertical axis. Sight point A again.
- ④ Loosen the telescope clamp screw, and reverse the telescope around the horizontal axis. Mark a point on the line of sight at about the same distance as point B, and call it mark C. (The telescope has now returned to its normal position.)
- ⑤ No adjustment is necessary if point B and C coincide.

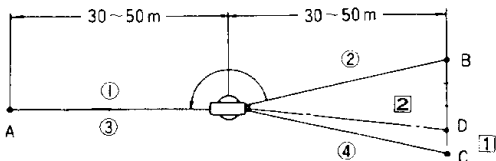

2 Adjustment

- ① If points B and C do not coincide, set up a point C located 1/4 of the length BC from the point C toward B.
- ② Turn the two cross hairs adjusting screws opposed horizontally by first loosening one, then tightening the other with the adjusting pin. Move the cross hair so that point D is set on the line of sight.
- ③ Repeat the inspection and check that the adjustment is correct.

(5) Vertical angle reading with line of sight horizontal

1 Inspection

- ① Set up as usual and turn the power on. (Set the mode to V/H)
 - ② Sight the telescope at any reference target A. Obtain vertical angle (r).
 - ③ Reverse the telescope and rotate the alidade. Sight again at A and obtain vertical angle (ϱ).
 - ④ If $r + \varrho = 360^\circ$, no further adjustment is required.
*If difference $d (r + \varrho - 360^\circ)$ is greater than the rated value, adjustment is required.
- If the horizontal 0° mode is used, $r + \varrho = 180^\circ$ or 540° .

2 Adjustment

- ① Turn the power off.
- ② While pressing **OSET**, press **ON/OFF** to turn the power on.

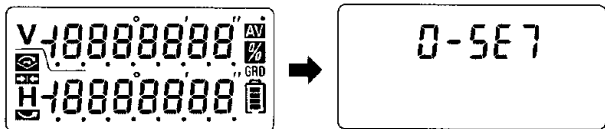

- ③ Index the vertical 0 point.

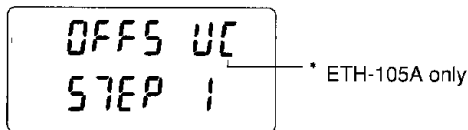

- ④ Sight the object A, and press **OSET**

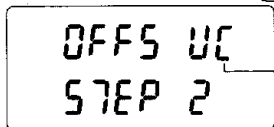

*ETH-105A only

- ⑤ Reverse the telescope and rotate the instrument. Sight the object A again with the telescope reversed, and press **OSET** (Adjustment completed).

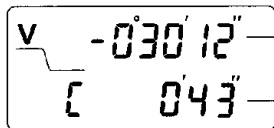

offset value for V.0 point

Vertical compensation
offset value

(ETH-105A only)



after 3 minutes

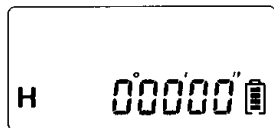

Horizontal angle measure-
ment mode is displayed.

- ⑥ Repeat from Inspection ① to make sure that adjustment is properly done.

■ In adjustment ⑤, display returns "STEP 1" when **OSET** is pressed if the telescope is sighted widely off the object (more than $\pm 5^\circ$).

In this case, reverse the telescope to the normal position and start adjustment with ④.

■ Be sure to precisely sight the telescope at the object.

(6) Coincidence of line of sight of optical plummet with vertical axis

1 Inspection

- ① Set the instrument on the tripod, and place a piece of white paper with a cross drawn on it right under the instrument.
- ② Look through the optical plummet, and move the paper so that the intersecting point of the cross comes to the center of the field of view.
- ③ Adjust the leveling screw so that the center mark of the optical plummet coincides with the intersection point of the cross.
- ④ Rotate the instrument around the vertical axis. Look through the optical plummet each steps of 90° rotation, and observe the center mark position against the intersection point of the cross.
- ⑤ If the center mark always coincides with the intersection point, no adjustment is necessary.

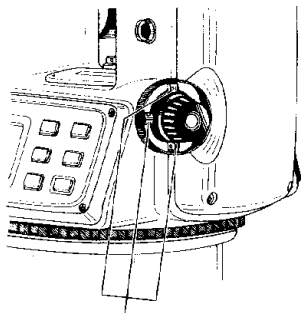
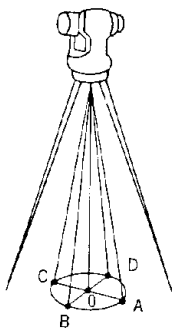

O.P. adjusting screws

2 Adjustment

- ① If the center mark does not coincide with the intersection point, rotate counterclockwise the cap put on focusing knob of optical plummet and then remove it.
- ② Mark the point set on the line of sight at each step of 90° on the white paper and call them A, B, C and D.
- ③ Join the opposed points (A, C and B, D) with a straight line, and set intersecting point O.
- ④ Turn four optical plummet adjusting screws with a adjusting pin so that the center mark coincides with the intersecting point O.
- ⑤ Repeat the intersection procedures starting with Inspection ④, and confirm if the adjustment is correct or not.

(7) Instructions on inspection and adjustment

- When inspecting and adjusting the instrument, take steps in numerical order as much as possible.
- Pay special attention to articles ③ ④ and ④ ⑤ so that steps for adjustment and inspection may be taken in numerical order.
- When adjustment is completed, be sure that adjusting screws are firmly tightened. Tighten the adjusting screw by turning the screw to the direction for tightening. When turning the screw back, tighten the screw after it is rotated too much.
- Repeat inspection after adjustment, and check if the instrument has been adjusted properly.

8. Optional Accessories

(1) Diagonal Eyepiece [SB10]

The diagonal eyepiece can be attached to the telescope eyepiece for convenience in observing the zenith or surveying in confined spaces. To attach the diagonal eyepiece to the telescope, turn the telescope eyepiece ring counterclockwise to remove the eyepiece, and attach the diagonal eyepiece by turning its ring clockwise. The eyepiece can be rotated through 360°.

When sighting is made through the telescope with the diagonal eyepiece attached, the reticule may be seen deflected vertically or horizontally, but this has no influence upon accuracy. It can be corrected with three adjusting screws if necessary.

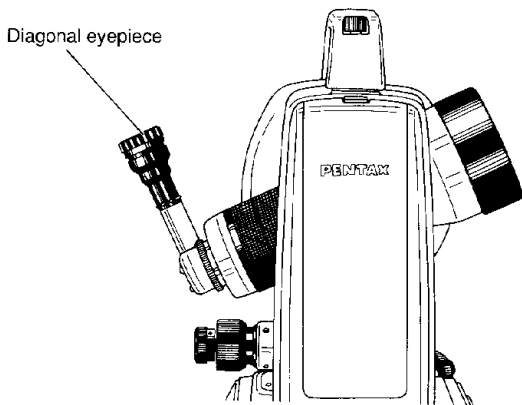

(2) Reticule filter [SE2]

A reticule filter [SE2] can be attached for the sun observation on the reticule.

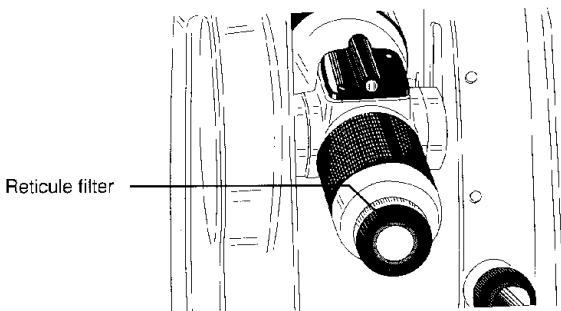

(3) Bar Compass [SC7]

Magnetic north can be obtained by mounting the bar compass onto the top handle.

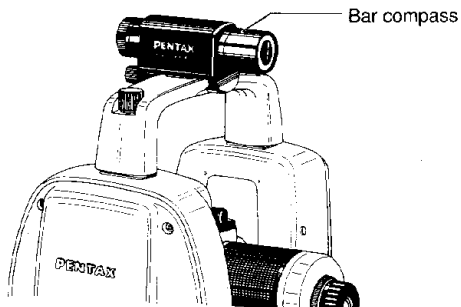

9. Specifications

■ Telescope

Magnification	30x
	26x (ETH-120C • 120F)
Effective aperture	45mm
Resolving power	3"
Field of view	2.6% (1° 30')
Minimum focus distance	0.85m
Stadia ratio	100
Stadia constant	0

■ Angle measurement

Type	Incremental rotary encoder
Detection mode (V)	Dual (ETH-105A/107/107C)
	Single (ETH-110C/110F/120C/120F)
(H)	Dual (ETH-105A/107/107C)
	Single (ETH-110C/110F/120C/120F)
Minimum display	(ETH-105A/107/107C): 10"/5" (20cc/10cc) selectable
	(ETH-110C/110F/120C/120F): 20"/10" (20cc/ 20cc) selectable
Accuracy (DIN18723)	ETH-105A : 5"
	ETH-107/107C : 7"
	ETH-110C/110F : 10"
	ETH-120C/120F : 20"
Diameter	79mm

■ Vertical angle compensation (ETH-105A)

Method	Automatic compensation
Type	Liquid reflecting
Range	± 3'

■ Display

Type	Segment LCD in two lines
Display panel	ETH-105A/107/107C/110C : Dual
	ETH-110F/120C/120F : Single

<p>■ Vertical axis</p>	<p>ETH-105A/107/107C : Dual ETH-110C/110F/120C/120F: Single</p>
<p>■ Sensitivity of vials</p>	
<p>Plate vial</p>	<p>ETH-105A/107/107C : 40"/2mm ETH-110C/110F/120C/120F: 60"/2mm</p>
<p>Circular vial</p>	<p>8 1/2mm</p>
<p>■ Tribach type</p>	<p>ETH-105A/107 : Detachable ETH-107C/110C/120C : Shifting ETH-110F/120F : Fixed</p>
<p>■ Optical Plummet</p>	
<p>Magnification</p>	<p>3x</p>
<p>Focusing range</p>	<p>0.5m ~ ∞</p>
<p>■ Power source</p>	
<p>Type</p>	<p>4 x AA dry battery</p>
<p>Voltage</p>	<p>6V</p>
<p>Operation time</p>	
<p>(Manganese)</p>	<p>ETH-105A/107/107C : 10 hrs. ETH-110C/110F/120C/120F: 23 hrs.</p>
<p>(Alkaline)</p>	<p>ETH-105A/107/107C : 28 hrs. ETH-110C/110F/120C/120F: 45 hrs.</p>
<p>■ Ambient temperature</p>	<p>-20°C ~ +50°C / -4°F ~ +122°F</p>
<p>■ Dimensions</p>	
<p>Instrument</p>	<p>L152 x H309 x W172mm/ L6.0 x H12.2 x W6.8in.</p>
<p>Carrying case</p>	<p>L210 x H380 x W240mm/ L3.8 x H15.0 x W9.4in.</p>
<p>■ Weight</p>	
<p>Instrument</p>	<p>ETH-105A/107/107C : 4.7 kgs/10.4 lbs.; ETH-110C/110F/120C/120F: 4.4 kgs/9.7 lbs.</p>
<p>Carrying case</p>	<p>2.1 kgs./4.6 lbs.</p>

This device complies with protection requirement for residential and commercial areas. If this device is used close to industrial areas or transmitters, the equipment can be influenced by electromagnetic fields

PENTAX[®]

ASAHI PRECISION CO., LTD

1-1-21, Shirako, Wako-shi,
Saitama-ken, 351-0101, Japan

Tel: +81-48-461-5377

Fax: +81-48-466-3979



The CE marking assures that
this product complies with
the requirements of the EC
directive for safety.

10.12.1998 Second edition

ET00201E

Printed in Japan