

Electronic Instruction manual Theodolites



- | | |
|----------------|---|
| ETH-302 | 2 sec. Angle Accuracy
Detachable Tribrach |
| ETH-305 | 5 sec. Angle Accuracy
Detachable Tribrach |
| ETH-310 | 10 sec. Angle Accuracy
Detachable Tribrach |
| ETH-320 | 20 sec. Angle Accuracy
Detachable Tribrach |

PENTAX Industrial Instruments Co., Ltd.

2-5-2 Higashi-Oizumi / Nerima-ku, Tokyo 178-0063, Japan

Tel. +81-3-5905-1222 / Fax +81-3-5905-1225

E-mail: international@piic.pentax.co.jp

Safety Precautions (must be followed)

The following items are intended to prevent possible injury to the user or other people and/or damage to the instrument before it occurs.

These safety precautions are important to the safe operation of this product and should be observed at all times.

● ***Distinctive Displays***

The following displays are used to distinguish precautions by the degree of injury or damage that may result if the precaution is ignored.



WARNING

Items indicated by this display are precautions which if ignored could result in death or serious injury.



CAUTION

Items indicated by this display are precautions which if ignored may result injury or material damage.

- Here "injury" refers to injuries such as cuts, burns or electric shock the treatment of which will not likely require hospitalization or long-term attention.
- "Material damage" refers to the damage to facilities, buildings, acquired data, etc.



WARNING

- Never look at the sun through the telescope as this may result in loss of sight.
- Do not use at a place near flammable materials as there will be a risk of fire or injury by explosion.



CAUTION

- Secure the handle of main unit with the handle locking screws. Failure to properly secure the handle could result in the main unit detaching from the handle while being carried, causing injury.
- Do not use the carrying case as a footstool as it is slippery and unstable and may cause you to fall, resulting in possible injury.
- When mounting the instrument to the tripod, tighten the center screw securely. Failure to tighten the screw properly could result in the instrument falling off the tripod causing injury.
- Securely tighten the leg fixing screws of the tripod. A person could be injured by the tripod shoes on an extending leg due to a loose screw.
- Do not carry a tripod with the metal shoe pointing toward another person as the person may be injured if they strike them.
- Make sure that your hands and feet are not in the vicinity of the tripod legs when setting up the tripod, or a hand or foot stab would occur.
- Do not wield or throw the plumb bob. A person could be injured if struck.
- If a battery box or a battery is gets wet by water, wipe off the water and dry immediately.
- When a battery box is removed from the unit, power must be off. If the battery box is removed with power on, it will cause trouble.

Electro-Magnetic Compatibility(EMC)

This instrument complies with the protection requirement for residential and commercial areas.

If this instrument is used close to industrial areas or transmitters, the equipment can be influenced by electromagnetic fields.

CONTENTS

• 1. General	7
1.1 Precautions	
1.2 Standard equipment	
1.3 Names of Parts	
1.4 Preparation of power	
• 2. Key Operations and Display	14
2.1 Display	
2.2 Keyboard	
2.3 Function of each key	
2.3.1 Power on-off key	
2.3.2 V/% key	
2.3.3 Hold key	
2.3.4 0 set key	
2.3.5 R/L key	
2.3.6 Illumination key	
2.4 Other functions	
2.4.1 Remaining battery indicator	
• 3. Special Key Operations	22
3.1 Setting of vertical angle	
3.2 Setting of 90°buzzer	
3.3 Setting of correction of vertical angle	
3.4 Setting of angle measurement	
3.5 Setting of automatic power-off function	
3.6 Setting of Angle unit	
• 4. Preparation for Surveying	28
4.1 Setting up the instrument	
4.2 Leveling with the circular vial	
4.3 Leveling with the plate vial	
4.4 Centering with the optical plummet	
4.5 Eyepiece adjustment	
4.6 Object sighting	

CONTENTS

• 5.	Measurement	34
5.1	Horizontal angle measurement (right)	
5.2	Horizontal angle measurement (left)	
5.3	Vertical angle measurement	
• 6.	Inspection and Adjustment	37
6.1	Instructions on inspection and adjustment	
6.2	Perpendicularity of plate vial to vertical axis	
6.3	Perpendicularity of circular vial to vertical axis	
6.4	Inclination of reticule graduations	
6.5	Perpendicularity of line of sight to horizontal axis	
6.6	Difference of the vertical angle	
6.7	Optical plummet	
• 7.	Optional Accessories	44
7.1	Diagonal eyepiece	
• 8.	Specifications	45

1. General



1.1 Precautions

Storing and environmental conditions

- Do not use the instrument until it has adjusted to the ambient temperature.
- Avoid using at a high or low temperature. The instrument may not work normally at temperatures exceeding -10 or $+50^{\circ}\text{C}$.
- When the instrument gets wet, wipe off the water immediately and let it completely dry outside of the case. Store in the case after completely dried.
- Be sure to store instrument in the case. Avoid storing in a place that is subject to high temperature, high humidity, or dust.
- When not in use for extended periods, remove a battery from the battery box. Also remove the instrument from the case and expose to the air periodically.



Battery

- Batteries can naturally discharge due to shipment time. Use new batteries for the first job.
- The four (4) batteries, in a battery box, should be of the same type.
- Do not use batteries, in a battery box, which have different remaining capacities.
- Do not touch the liquid of leaking batteries.

Transportation

- Do not subject to impact or vibration during transportation.
- When transporting, handle the same as "fragile" and pack the shipping case with cushioning materials.

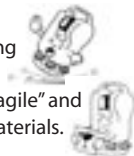

Inspection, Adjustment and Repair, Overhaul

- When not in use for extended periods of having been subjected to impact or vibration, be sure to check the instrument adjustments before using.
- If there is any problem in the instrument, do not attempt to repair or you may make the problem worse.



Contact your local dealer for proper repair or instructions.

Others

- When cleaning the case or the instrument, do not use any organic solvent. The surface of plastic parts may dissolve and deformation and discoloration can occur.
Wipe off the dirt with a wet cloth of dilute household detergent
- Wipe off dirt on the optics with a cleaning cloth (or paper) specified for optical surfaces.
- To realize full capability of the instrument, adhere to cautions described in each chapter of this manual.



1.2 Standard Equipment

- Body (with objective cap)
- Battery box (One battery box is installed in the instrument)
- Batteries* (Contained in the carrying case)
- A set of tools (Adjusting pin, driver)
- A plumb bob
- Rain cover
- Carrying case
- Instruction manual

* *The standard equipment AA batteries can naturally discharge due to shipment time. Use new batteries for the first job.
When disposing used batteries, please follow your municipal government rules.*

Unpacking and Storing

Unpacking

- Gently set down the carrying case so that its cover is upward.
- Unlatch and open the case while pushing the latch lock.
- Take the instrument out of the case.

Storing

- Set the telescope almost horizontal, and lightly tighten the telescope clamp screw.
- Align the containing marks*, and lightly tighten the horizontal clamp screw.
- Insert the instrument into the case with the containing marks* facing upward.
- Close the case lid and lock the latches.

* *Containing mark = Yellow dot sticker*

1.3 Names of Parts

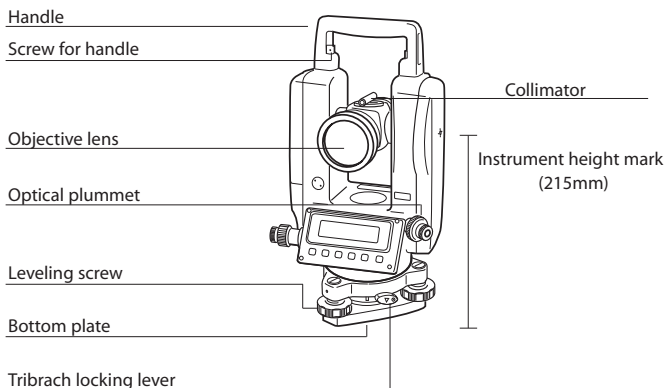

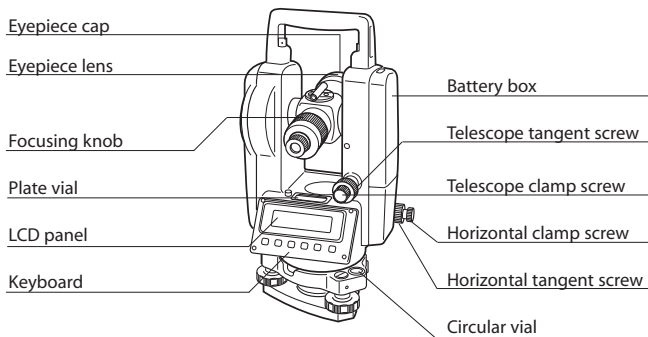

1.4 Preparation of Power

- Remove battery box from the unit by pushing the release button on the top of the battery box. Remove the battery box cover.
- Insert four AA batteries into the battery box according to (+) and (-).
- **Press the battery box to the leg by inserting the guide pin to the guide** groove.
- Confirm the correct work by pressing the power switch.

This instrument can operate using 1.2V AA rechargeable batteries.

- The four (4) batteries, in a battery box, should be of the same type. Do not use batteries, in a battery box, which have different remaining capacities.
- When a battery box or batteries are wet, wipe off the moisture immediately and dry completely.
- When a battery box is removed from the unit, power must be off. If the battery box is removed with power on, it will cause trouble.

2. Key Operations and Display

2.1 Display

Vertical angle

V=Zenith 0° , V%=Slope(VH=Horizontal 0° , Vc=Compass)

V	192°	34'	20"
HR	267°	58'	00"

Horizontal angle Battery indicator: 

(HR=right rotation horizontal angle, HL=left rotation horizontal angle)

2.2 Keyboard

[V/%] key (Switches the display of vertical angle)

[R/L] key (Set the horizontal angle right and left rotation alternately)

[HOLD] key (Pressing twice holds the horizontal angle shown on the display)

[OSET] key (Pressing twice resets the horizontal angle to $0^\circ,00',00''$)

 Illumination key (Illuminate LCD panel and the telescope reticle)

[ON/OFF] key (Turns the power on and off alternately)

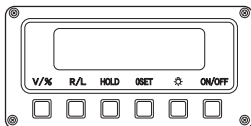

2.3 Function of each key

2.3.1 Power [ON/OFF] key

① <Power ON and set the vertical angle 0 point>

Pressing the ON/OFF key turns on the power supply and the message "0 SET" is displayed. After the "0 SET" of vertical angle is performed, the Horizontal and Vertical angle are displayed and the instrument enters into the angle measurement mode.



U 0SET
HR: 0° 00' 00" ■

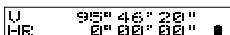

U 95° 46' 20"
HR: 0° 00' 00" ■

② <Setting vertical angle 0 point>

Set the vertical angle 0 point by turning the telescope upward or downward when the instrument is at the "normal" position (Vertical circle at left.)

③ <Power OFF>

To turn the power supply off, press the ON/OFF key for more than 1 second ("OFF" will display) and then release it. Power turns OFF.

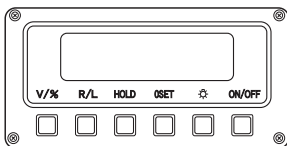

2.3.2 [V/%] key

Pressing the V/% key will change the Vertical angle display to V%(slope). (At the shipping, it is set at Zenith 0°)

By special key operation, horizontal 0° (VH) and Compass (Vc) can be set.

(Factory default is Zenith 0°)

(Refer to 3.1 Setting of vertical angle.)

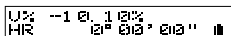

```
V%: --1 0.10%
HR 12° 00' 00" 00
```

The error "OVER RANGE" is displayed when the telescope exceeds 45°(100%) in the V% display mode.

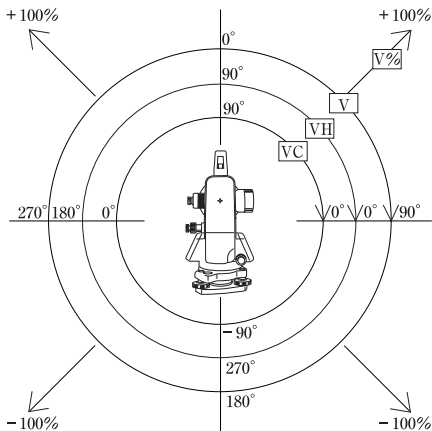

2.3.3 [HOLD] key

- ① Press the [HOLD] key twice in succession to hold the displayed horizontal angle and retain it. (Press once, the key buzzer will sound, then press again during the sound.)
- ② Press the key once more to release.

To prevent operation error, the buzzer sounds for three seconds when the [HOLD] key is pressed.

HOLD is not initiated unless the key is pressed during the buzzer sound.

U	1	92°	34'	28"
HOLD	67°	58'	08"	▬

2.3.4 [OSET] key

- ① Press the [OSET] key twice in succession to reset the displayed horizontal angle $0^{\circ}00'00''$. (Press once, the key buzzer will sound, then press again during the sound.)
- ② Press the key once more to release.

To prevent operation error, the buzzer sounds for three seconds when the [OSET] key is pressed.

[OSET] is not initiated unless the key is pressed during the buzzer sound.

U	192°34'20"
HR:	0°00'00" ■■

U	192°34'20"
HR:	0°00'00" ■■

2.3.5 [R/L] key

Press the [R/L] key to change from clockwise to counterclockwise rotation. A clockwise or counterclockwise reading is alternately displayed each time the key is pressed.

- ① Clockwise horizontal angle Count horizontal angle in a right rotation direction (HR)
- ② Counterclockwise horizontal angle Count horizontal angle in a left rotation direction (HL)

If the power turns off during the counterclockwise mode, the display returns to a clockwise horizontal angle display when power is turned on.

U	1	52	34	20	"
HR	67	58	00	"	■

U	1	52	34	20	"
HL	292	02	00	"	■

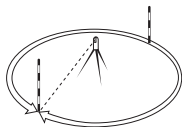

2.3.6 [Illumination key

Pressing the  key, illuminates the LCD panel and telescope reticule. The illumination is automatically turned off after five minutes. Pressing the key, with illumination on, turns off the illumination.

2.4 Other Functions

2.4.1 Remaining battery indicator

The status of the remaining battery capacity is displayed with "  " symbolizing the battery capacity.

Battery full - operating possible



Operation possible



Operation still possible



Get the battery ready for a stand by



Replace batteries



Automatic Power-off function

If there is no key operation for about 30 minutes, the power supply is turned off automatically.

This function can be set to NIL by special key operation. (Refer to 3.5 Setting of automatic power off function.)

3. Special key operations

Special key operation enables selection of angle unit and other such items.

① Press [HOLD] key and [0SET] key at the same time

② Press [ON/OFF] key



WELCOME!

③ Release [ON/OFF] key

④ (No display or buzzer)

Release [HOLD] key and [0SET] key,

⑤ Following display appears:

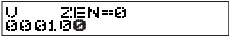

U 21E14==0
0001.00

Flow of setting display

Setting of vertical angle

```
U  ZEN=0
000100
```

Press [R/L] key

Setting of 90°buzzer

```
NO. BEEP
000100
```

Press [R/L] key

Setting of correction of vertical angle

```
TILT. ON
000100
```

Press [R/L] key

Setting of angle display

```
MIN 5
000100
```

Press [R/L] key

Setting of automatic power off function

```
30 OFF
000100
```

Press [R/L] key

Setting of Angle unit

```
360
000100
```

Previous items can be displayed by pressing the [HOLD] key.

3.1 Setting of Vertical Angle

Vertical angle setting display by special key operation

Zenith 0° (V)

Setting is switched by pressing [0SET] key

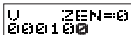

U ZEN=0
000100

Horizontal angle 0°(VH)

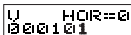

U HOR=0
000101

Compass (Vc)



U COMPASS
000102

Store with [V/%] key when the setting is decided.

3.2 Setting of 90°buzzer

90°buzzer setting display by special key operation

No 90°buzzer

NO BEEP
000100

Setting is switched by pressing [0SET] key
With 90°buzzer

90 BEEP
000110

Store with [V/%] key when the setting decided.

3.3 Setting of correction of vertical angle

Correction of vertical angle setting display by special key operation

TILT. ON
000100

Setting is switched by pressing [0SET] key

TILT. OFF
000000

Store with [V/%] key when the setting decided.

3.4 Setting of angle measurement

Angle setting display by special key operation

① For models ETH-302/305

MIN 5"
000100

MIN 1"
001100

Setting is switched by pressing [OSET] key
Store with [V/%] key when the setting decided.

② For models ETH-310

MIN 12"
000000

MIN 5"
001000

Setting is switched by pressing [OSET] key
Store with [V/%] key when the setting decided.

③ For ETH-320

MIN 20"
000000

MIN 10"
001000

Setting is switched by pressing [OSET] key
Store with [V/%] key when the setting decided.

3.5 Setting of automatic power off function

Automatic power off function setting display by special key operation

Automatic power off active

Setting is switched by pressing [0SET] key

A rectangular LCD display showing two lines of text. The top line displays '30 OFF' and the bottom line displays '000100'.

Automatic power off inactive

A rectangular LCD display showing two lines of text. The top line displays 'NO OFF' and the bottom line displays '010100'.

Store with [V/%] key when the setting decided.

3.6 Setting of Angle unit

Setting is switched by pressing [0SET] key

You can Select DEG or DEC or GRD or MIL as the unit for angle.

A rectangular LCD display showing two lines of text. The top line displays '360' and the bottom line displays '000100'.

Store with [V/%] key when the setting decide.

4. Preparation for Surveying

4.1 Setting up the instrument

- ① Adjust the tripod legs so that a height suitable for surveying is obtained when the instrument is set on the tripod.
- ② A Set the tripod and fix the metal shoe firmly into the ground so that the tripod head is as level as possible and centered above the station point. If the tripod head is disturbed by the action of fixing the metal shoe into the ground, correct the level by extending or retracting each leg of the tripod.
- ③ Set the instrument on the tripod head; insert the tripod center screw into the instrument bottom plate and tighten firmly.

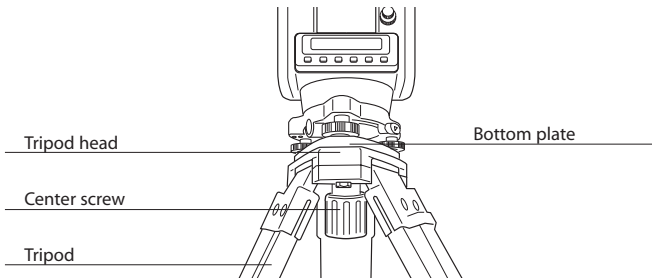

4.2 Leveling with the Circular level

After [4.1 Setting up the instrument] is completed, instrument must be leveled using the circular vial.

- ① By rotating any two leveling screws, position the bubble in the center of the vial (See A.) (To adjust the screws at the same time, turn them in opposite directions.)
- ② Adjust the remaining leveling screw, and position the bubble in the center of the circle (See B)

For the relation between the screw adjusting direction and bubble moving direction, refer to the arrows of the following figures. Bubble will move to the right in figure A, while in figure B it moves upward.

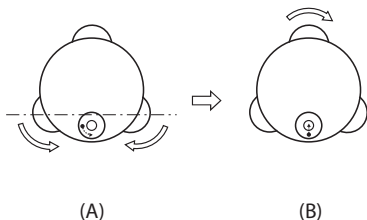

4.3 Leveling with the Plate level

After [4.2 Leveling with the circular vial] is completed, instrument must be leveled with plate vial.

- ① Place the plate vial in parallel with a line joining any two of the leveling screws. By rotating two leveling screws in the opposite direction of each other, position the bubble in the center of the vial (See A)
- ② Rotate the plate vial through 90°, position the bubble in the center of the vial by operating the remaining one leveling screw (See B)
- ③ Confirm if the bubble stays in the center by rotating the instrument 180°.
If the bubble moves, repeat procedure ① and ②.

For the relationship between the screw adjusting direction and bubble moving direction, refer to the arrows of following figures. Bubble will move to the left in figure A, while in figure B moves upward.

When the bubble is not positioned in the center by repeating procedure ① and ② in procedure 4.2, adjustment is required. (Refer to [6.Inspection and Adjustment.])

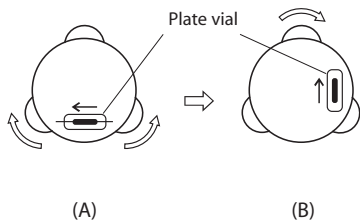

4.4 Centering with the optical plummet

After [4.3 Leveling with the plate vials] is completed, the instrument must be centered above the station point.

- ① Focus the optical plummet reticule by rotating the optical plummet eyepiece knob.
- ② Focus the station point by rotating the optical plummet focusing knob.
- ③ Loosen the tripod center screw. Look through the optical plummet eyepiece, and move the instrument bottom plate until the reticule center coincides with the station point. (Take care not to rotate the instrument)
- ④ Tighten the tripod center screw. Ascertain that the bubble stays positioned in the center when rotating the plate vial position in steps of 90° . If the bubble is not positioned in the center, adjust with the leveling screws. (Refer to [4.3 Leveling with the plate vial]).

Even if the bubble is shifted by one graduation in ④, deviation of centering is just 0.3mm, at the instrument height of 1.4m, giving little effect on the survey result.

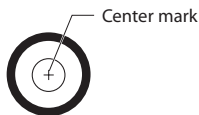

4.5 Eyepiece adjustment

After [4.4 Centering with the optical plummet] completed, focus the telescope eyepiece on the telescope reticule.

- ① Remove the telescope lens cap.
- ② Point the telescope at a bright object.
- ③ Rotate the eyepiece completely counterclockwise.
- ④ Look through the eyepiece, and rotate the eyepiece clockwise until the reticule appears at its maximum sharpness.

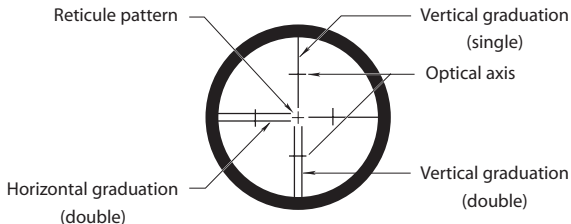

At procedure ④, keep your eye relaxed to prevent parallax and eye fatigue. Parallax causes problems with object sighting. (Refer to [4.6 Object sighting])

4.6 Object sighting

After [4.5 Eyepiece adjustment] is completed, sight the object.

- ① Loosen the telescope clamp screw and horizontal clamp screw.
- ② Point the telescope at the object using the collimator sight.
- ③ Tighten the telescope clamp screw and horizontal clamp screw.
- ④ Focus on the object by rotating the focusing ring, while looking through the telescope.
- ⑤ Accurately align the reticule with the object, using each tangent screw.

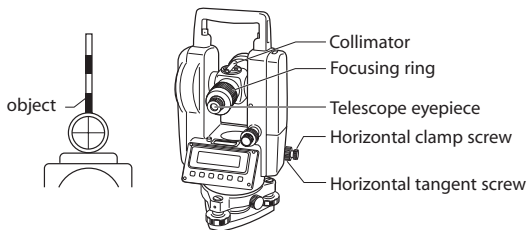

- In procedure ④, focus on the object correctly so that the reticule will not move in relationship to the object when you move your eye slightly left and right, while looking through the eyepiece.
- Turn the focusing ring clockwise to focus on a near object. Turn the focusing ring counterclockwise to focus on a far object.
- Two screws of the collimator are fixed and adjusted at the distributor or the manufacturer. Do not move them arbitrarily.

5. Measurement

5.1 Horizontal angle measurement (right)

- ① Level the instrument, and after power on set the vertical angle 0 point.
- ② Sight the first object using the horizontal clamp and tangent screw as well as the telescope clamp and tangent screw.
- ③ Press [OSET] twice to set the horizontal angle to $0^{\circ}00'00''$
- ④ Sight the second object using the horizontal clamp and tangent screw as well as the telescope clamp and tangent screw.
- ⑤ Read the displayed value (α).

First Object: Zero Setting ($0^{\circ}00'00''$)

U	02° 34' 20"
HR	00° 00' 00"

Second Object ($34^{\circ}47'20''$)

U	02° 34' 20"
HR	34° 47' 20"

Horizontal Angle (α) = $34^{\circ}47'20''$

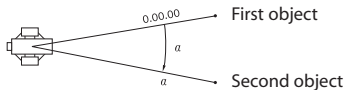

5.2 Horizontal angle measurement (left)

- ① Level the instrument, and after the power on set the vertical angle 0 point.
- ② Sight the first object using the horizontal clamp and tangent screw as well as screw as well as the telescope clamp and tangent screw.
- ③ Press the [R/L] key to switch the horizontal angle display to counterclockwise reading (HL).

Subsequent operation will be done as in [5.1 Horizontal angle measurement (right)], but the order of collimation is reversed.

To switch the mode back to "right", press the [R/L] key again.

- If the power turns off during the counterclockwise mode, the display returns to a clockwise horizontal angle display when power is turned on.

LI	92° 34' 20"
HL	0° 00' 00" ■■

5.3 Vertical angle measurement

Level the instrument, turn the power on and set the vertical angle 0 point.

Sight the object A using the horizontal clamp and tangent screws as well as the telescope clamp and tangent screws.

Read the displayed value ().

- The vertical angle mode can be changed to slope percent display (V%) by pressing [V%] key.
Also, horizontal 0°(VH) and compass (Vc) can be set using special key operation.
(Factory setting is Zenith 0°)
(Refer to 3.1 Setting of vertical angle)

Vertical angle (θ) = 86 °24' 40"

Press the [V/%] key to view the Vv and V%.

V	92° 34' 20"
HL	0° 00' 00" 

V	86° 24' 40"
HR	0° 00' 00" 

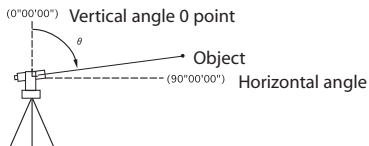

6. Inspection and Adjustment

6.1 Instructions on inspection and adjustment

- Inspection and adjustment should be done after setting the instrument on a tripod or on an adjustment stand.
- Inspection should be done sequentially from [6.2 Plate vial] to [6.5 Perpendicularity of line of sight to horizontal axis]
- Adjustments should be finished with adjustment screws having been tightened and with firm torque. Do not finish by loosening an adjustment screw.
- Repeat inspection after adjustment and confirm if the adjustment is performed correctly.
- It is recommended that a trained professional perform adjustments, if possible.

6.2 Perpendicularity of plate vial to vertical axis

Inspection

- ① Perform [4.3 Leveling with the horizontal vial]
- ② Rotate the instrument through 90° and confirm if the bubble is always in the center.
- ③ When the bubble is in the center, no adjustment is necessary. If the bubble moves from the center, following adjustment is required.

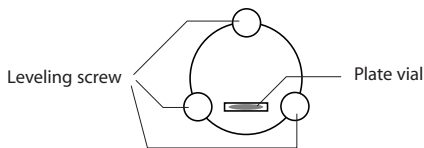

Adjustment

- ① Center the plate vial bubble.
- ② Rotate the instrument 180° , move the bubble half way back to the center by operating a leveling screw which is located parallel with the plate vial.
- ③ Rotate the vial adjusting screw with the adjusting pin and position the bubble in the center.
- ④ Repeat procedure again to confirm.

6.3 Perpendicularity of circular vial to vertical axis

Inspection

- ① Confirm if the bubble of the circular vial is in the center after the inspection and adjustment of [6.2 Plate vial].
- ② No adjustment is necessary if the bubble of the circular vial is in the center but if not, the following adjustment is required.

Adjustment

- ① Move bubble to the center by rotating the bubble adjusting screws, using the adjusting pin.
- ② Inspect again.

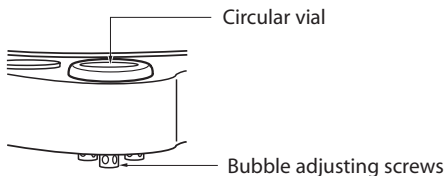

6.4 Inclination of reticule graduations

Inspection

- ① Set an object point A on the line of sight through the telescope.
- ② Move point A to the edge of the field of view by adjusting the telescope tangent screw (point A').
- ③ No adjustment is necessary if point A moves along the vertical line of the reticule. If the point A does not move along the vertical line of the reticule, it needs adjustment - Consult with your dealer.

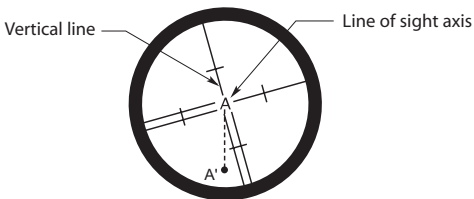

6.5 Perpendicularity of line of sight to horizontal axis

Inspection

- ① Set an object (point A) at a distance of 30 to 50m away from the instrument and sight it through the telescope.
- ② Loosen the telescope clamp screw and reverse the telescope around the horizontal axis. Mark a point set on the line of sight at about the same distance to the object point A, and call it point B.
- ③ Loosen the horizontal clamp screw, and rotate the instrument around the vertical axis. Sight point A again.
- ④ Loosen the telescope clamp screw, and reverse the telescope around the horizontal axis. Mark a point on the line of sight at about the same distance as point B, and call it point C.
- ⑤ No adjustment is necessary if point B and C coincide, but if it does not - Consult with your dealer.

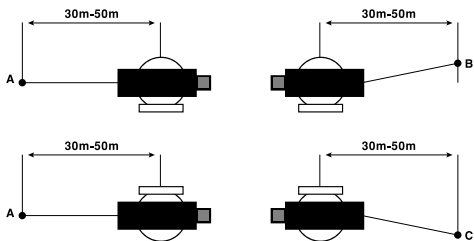

6.6 Difference of the vertical angle

Inspection

- ① Set the vertical angle in Zenith 0° mode
- ② Sight an object (Point P) with the telescope and read the vertical angle (V correct).
- ③ Reverse the telescope and rotate the alidade.
- ④ Sight point P again in the reverse position and read the vertical angle (V reverse).
- ⑤ At this time, when $(V \text{ correct} + V \text{ reverse} - 360^\circ)/2$ is less than 15", it is within tolerance. If it shows a larger value, it needs adjustment - Consult your dealer.

6.7 Optical plummet

Inspection

- ① Place a piece of white paper, with a cross drawn on it, directly under the instrument.
- ② Look through the optical plummet, and move the paper so that the intersecting point of the cross comes to the center of the field of view.
- ③ Adjust the leveling screws so that the center mark of the optical plummet coincides with the intersection point of the cross.
- ④ Rotate the instrument around the vertical axis. Look through the optical plummet each step of 90° rotation, and observe the center mark position against the intersection point of the cross.
- ⑤ If the center mark always coincides with the intersection point, no adjustment is necessary. When it does not coincide, the following adjustments are required.

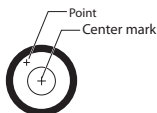

Adjustment

- ① Remove the cover of the optical plummet.
- ② Mark the point set on the line of sight at each step of 90° on the white paper and call them A, B, C and D.
- ③ Join the opposed points (A, C and B, D) with a straight line, and set intersecting point O.
- ④ Turn four optical plummet adjusting screws with the adjusting pin so that the center mark coincides with the intersection point O.
- ⑤ Repeat procedure again to confirm.

Optical plummet adjusting screw

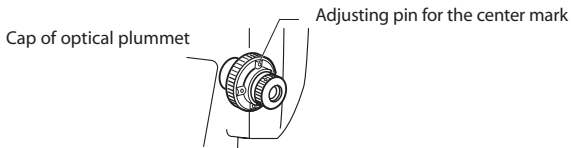

7. Optional Accessories

7.1 Diagonal Eyepiece (SB14)

The Diagonal eyepiece can be attached to the telescope for convenience in observing the zenith or when in confined spaces.

<Installation>

- ① Turn the telescope eyepiece ring counterclockwise to remove the eyepiece.
Be sure to hold the eyepiece, securely, so that you do not drop it.
Attach the diagonal eyepiece to the telescope by reversing the procedure.

The diagonal eyepiece can be rotated through 360°.

When sighting through the telescope with the diagonal eyepiece attached, the reticle may be seen deflected vertically or horizontally, but this has no influence upon accuracy.

8. Specifications

Telescope

Magnification	30 X
Effective aperture	45 mm
Resolving power	3"
Field of view	1° 30'
Minimum focus distance	1.35 m
Stadia ratio	100
Stadia constant	0

Angle Measurement

Type	Incremental rotary encoder	
Detection mode	V. angle:	Single
	H. angle:	Dual

Minimum Display (Selectable)

ETH-302 1"/5"

ETH-305 1"/5"

ETH-310 5"/10"

ETH-320 10"/20"

Accuracy (DIN18723, Standard deviation)

ETH-302 2"

ETH-305 5"

ETH-310 10"

ETH-320 20"

Vertical Angle Compensation

Method	Automatic compensation
--------	------------------------

Stadia Ratio 100

Stadia Constant 0

Display

Type	Dot matrix LCD/Two lines
Display panel	Dual display

Vertical axis

Single

Sensitivity of vials

Plate vial

ETH-302	30"/2 mm
ETH-305	30"/2 mm
ETH-310	40"/2 mm
ETH-320	40"/2 mm

Circular vial 8'

Tribrach type

Detachable

Optical plummet

Magnification	3 x
Focusing range	0.5 m to Infinity

Power source

Type	4 x AA dry battery
Operation time (Alkaline)	25 to 28 hrs.
(NiMH2300mAh)	25 to 28 hrs.

Water resistant

IP x4

Ambient temperature

- 10 °C to + 50 °C

Height

215 mm

Dimensions

Instrument (including batteries) W168 x H330 x L158mm/4.6kg

PENTAX Industrial Instruments Co., Ltd.

2-5-2 Higashi-Oizumi
Nerima-ku, Tokyo 178-0063, Japan
Tel.: +81-3-5905-1222
Fax: + 81-3-5905-1225
E-mail: international@piic.pentax.co.jp



for your
precious moments



The CE marking assures that
this product complies with
the requirements of the EC
directive for safety.



*Member symbol of the Japan Surveying
Instruments Manufacturers' Association
representing the high quality surveying
products.*