

PENTAX

ELECTRONIC LEVEL

PLP-2/PLP-3

Instruction manual

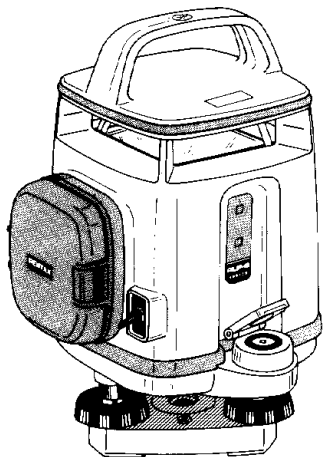

ASAHI PRECISION CO., LTD.

For proper and efficient operation of the instrument, read the instructions through carefully.

Contents

1. For proper use of instrument	4
1.1 Precautions	4
1.2 Standard configuration	8
1.3 Description	9
1.4 Unpacking	11
1.5 Battery insertion	12
2. Preparation for measurement	14
2.1 Setting up the tripod	14
2.2 Setting up the instrument	16
2.3 Arranging the detector (LS 2)	18
3. Measurement	19
3.1 Operating the instrument	19
3.2 Operating the detector (LS 2)	20
4. Maintenance and adjustment	26
4.1 Maintenance after use	26
4.2 Check and adjustment of the circular vial	28
4.3 Check and adjustment of the datum position	31
4.4 Troubleshooting	33
5. Specifications and optional accessories	34
5.1 Specifications	34
5.2 Optional accessories	35
6. Notice to the user of this product	36

Features

<PLP-2/PLP-3>

- Instrument is simply set up by leveling the circular vial. Precise leveling is done, then, by the automatic compensator, assuring an accurate horizontal plane created by the rotating laser beam.
- When the instrument is titled, out of automatic compensation range, the beam is cut and rotation stops to prevent incorrect measurement. If such inclination occurs, a warning light (orange) starts blinking to alert you to it.
- When the battery is running down, a warning light (red) starts blinking to indicate that the batteries need to be replaced.
- A mirror on the circular vial gives an optimum view even when the instrument is at eye height.
- The instrument can be mounted on either a flathead tripod or a domed-head tripod.

(Detector LS 2)

- Switchable two step accuracy selection provides better measurement efficiency according to the application or surrounding conditions at the job site.
- Audio signal sounds in three different tones, for HIGH, LOW and ON, and the display indicates needed direction of detector movement. This provides quick acquisition of the reference beam. The audio signal can also be cut off, if not required.
- The liquid crystal display can be illuminated to permit use in a dark conditions.
The display automatically turns off in one minute after being illuminated.
- The circular vial on the detector facilitates plumbing the staff or plain rod.
- The remaining battery capacity is indicated on the display in five steps, preventing the interruption of work.
- The power automatically turns off when the detector is not used for 10 minutes. This prevents unnecessary battery drainage.

1. For proper use of instrument

1.1 Precautions

Storage and environmental conditions

- * The instrument should not be stored or used in extreme temperatures or job on a place subject to rapid change of temperature.
(Refer to the ambient temperature range.)

The instrument may not function properly if used out of the ambient temperature range.

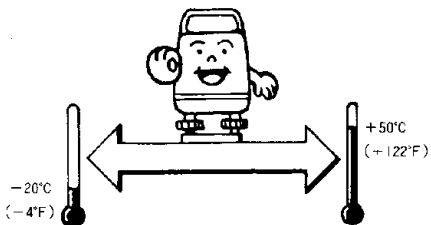

- * The instrument should be stored in the carrying case, avoiding a place subject to vibration or exposed to moisture and dust.

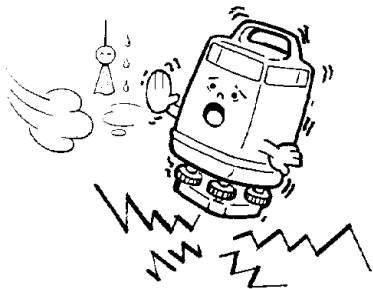

- * When the temperatures between the place for storage and usage is widely different, let the instrument stabilize to the new temperature before using.

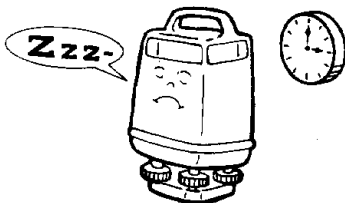

Transport and carrying:

- * The instrument should be transported or carried carefully to avoid impact or vibration.

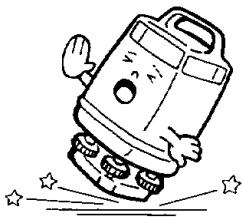

- * The instrument should be stored in the carrying case and packed with cushioning material, and handled with care as "Fragile".

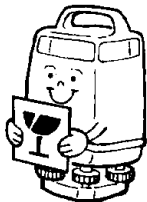

Laser beam:

- * While the instrument is operating, be careful not to expose your eyes to the emitting laser beam (red light source).
Exposure to a laser beam for a long time may be hazardous to your eyes.

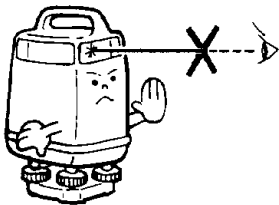

Other points to be observed:

- * After the instrument has been stored a long time or it has suffered an impact or vibration be sure to check to see if trouble exists before it is used. If any trouble exists, adjust or have it repaired.

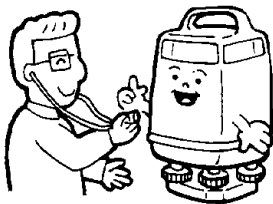

- * Do not try to dismantle the instrument. Have it repaired by your dealer or authorized repair shop. Dismantling it by yourself may worsen the trouble.

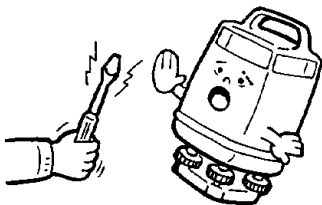

- * Be sure to observe the items in this instruction manual for proper use of the instrument.

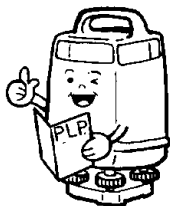

Instruction manual

1.2 Standard configuration

◇ The instrument (PLP-2/PLP-3)	1
Battery holder (LB 2)	1
Dry batteries (Type C)	4
◇ Detector (LS 2)	1
Battery (006P-9V)	1
◇ Rod adaptor (LA 2)	1
◇ Carrying case	1
Hexagon wrench (2.5mm)	1
Adjusting pin	1
Cleaning brush	1
Rain cover	1
Silicon cloth	1
Instruction manual	1

1.3 Description

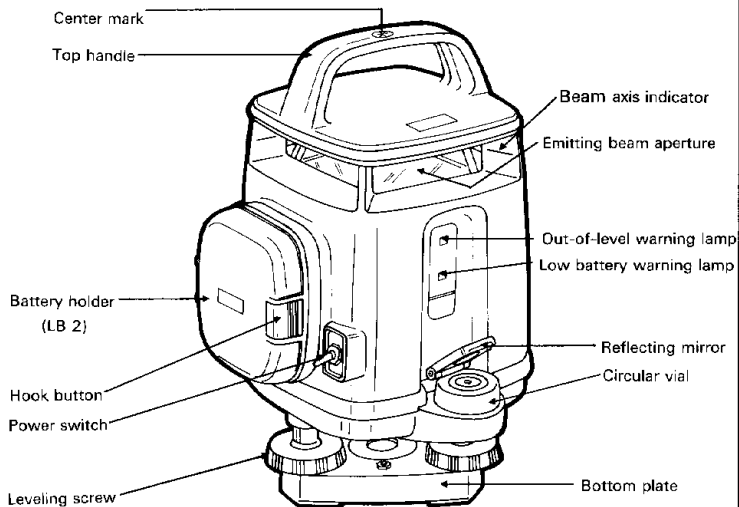

PLP-2/PLP-3

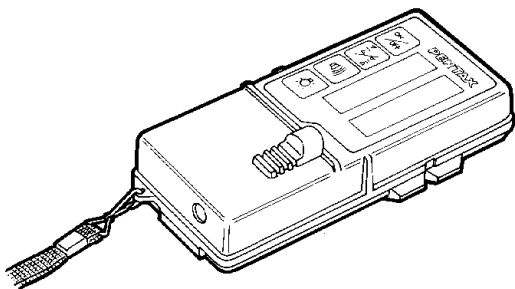

Detector LS 2

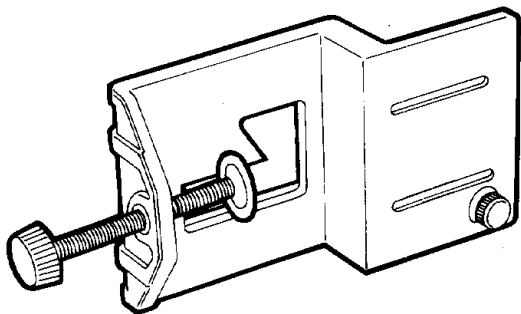

Rod adaptor LA2

1.4 Unpacking

(Taking the instrument out of the carrying case)

- ① Gently set down the carrying case so that its cover is upward.
- ② Unlatch and open the case while pushing the latch lock (safety device).
- ③ Remember how the instrument is placed in the case before removing it.

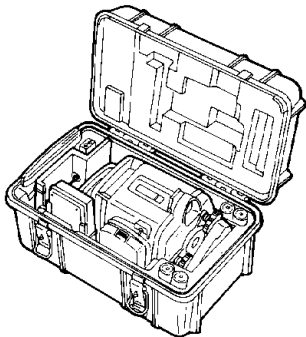

(Putting the instrument into the carrying case)

- ① Set down the carrying case and open the cover.
- ② Gently put the instrument into the case.
- ③ Close the case and secure the latch.

Note

- * When taking out the instrument, be sure to secure it with your hands.
- * When putting the instrument into the case, be sure to turn the power switch off.

If the power switch is on, a warning light (orange) blinks.

- * If the case cover is difficult to close, check again whether or not the instrument is properly placed inside the case.

1.5 Battery insertion

(Battery insertion for the instrument)

- ① Push the hook buttons on both sides of the battery holder and remove the battery holder from the instrument.
- ② Insert four dry batteries (Type C) into the battery holder according to its (+) and (-) marks.
- ③ While holding the instrument with one hand, push the battery holder into the instrument until it clicks.

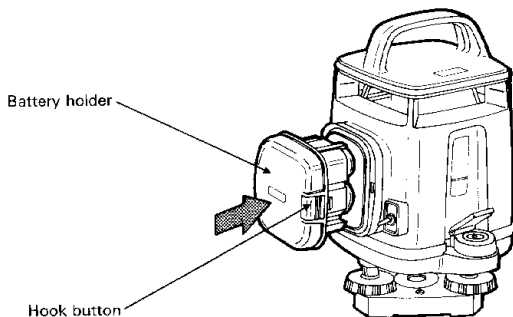

(Battery insertion for the detector)

- ① Slide the battery cover while pushing its ▲ mark and remove it.
- ② Insert a dry battery (006P-9V) into the battery holder according to its (+) and (-) marks.
- ③ Slide the battery cover to reinsert it.

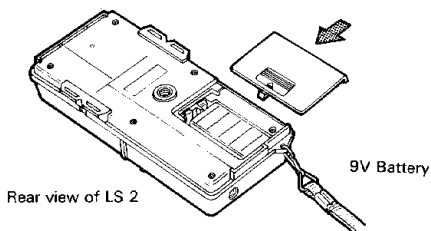

Caution

- * Pay attention to the battery holder's (+) and (-) marks for proper battery insertion.
- * Four 1.2V chargeable batteries (type C) can also be used, but reliable high quality ones must be used.
- * Batteries must be of the same type.
- * Do not use a combination of batteries whose remaining capacity differs, or mix standard and rechargeable types.

2. Preparation for measurement

2.1 Setting up the tripod

(Arranging the tripod)

- Use a tripod having a center screw with $5/8" \times 11$ thread.
- Any domedhead or elevation tripod with a center screw of this type can be used.

(Selecting the place to set up the tripod)

- Be sure to select a place where the job will not be interrupted and the instrument can be set to have almost same distance to each point to be measured.

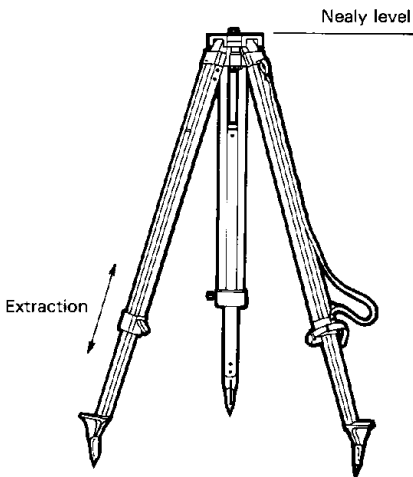

(Setting up the tripod)

- ① For an extension tripod, adjust the legs to a suitable length and secure the leg clamps.
- ② Spread the legs to a proper extent for the tripod head to be nearly level and push them into the ground.
- ③ Should the tripod head be off level, adjust it by expanding the legs accordingly.

Note

- * Be sure to use our genuine tripods marked "PENTAX" or those with reliable quality.
- * For a tripod setting up place, be sure to select a place where the ground or floor has less vibration and there is not fear of upset.
- * To set up the tripod on a slippery floor, the legs must be secured. Use a chain (or similar) to keep the legs from spreading.

2.2 Setting up the instrument

(Mounting on the tripod)

Mount the instrument on the tripod head and while supporting the instrument with one hand, secure it using the tripod center screw.

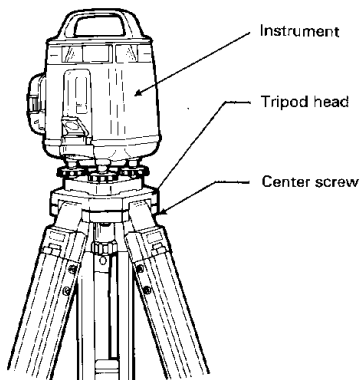

Note

- * Also when removing the instrument from the tripod, loosen the center screw while supporting the instrument with one hand.
- * Do not leave the instrument mounted on the tripod without the center screw being tightened. It may cause the instrument to fall and be damaged.

(Leveling the instrument)

- ① Turn any two leveling screws to move the bubble to a position halfway between the right and left in relation to the direction of the line connecting the two leveling screws. In this case, turn the screws in opposite directions.
- ② Turn only the remaining screw to set the bubble in the center of the circle.

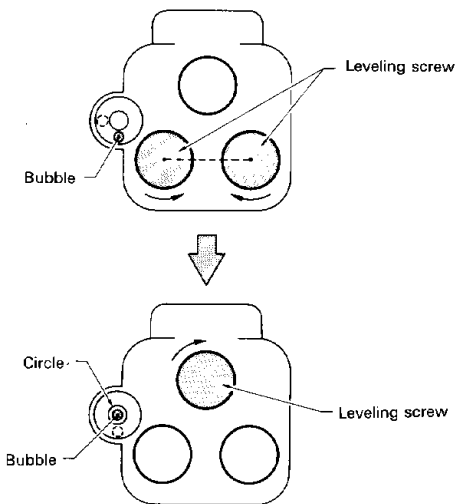

Note

- * For the relationship between the leveling screw's direction of rotation and bubble's direction of movement, refer to the arrows in the above figure. For skillful leveling, learn that the bubble moves in the direction of movement of the left hand thumb or in the opposite directions to the movement of the right hand thumb.

2.3 Arranging the detector (LS 2)

(Installing the rod adaptor (LA 2))

- ① Mount the detector on the rod adaptor so that the guide pin of the rod adaptor is inserted into the guide hole in the back of the detector.
- ② Tighten the attaching screw of the rod adaptor into the detector.

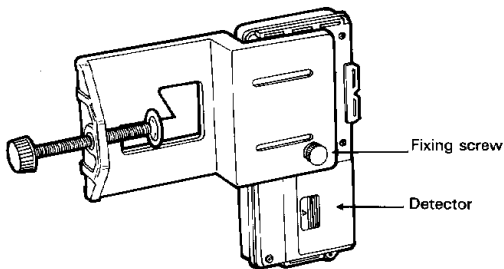

Note

- * The rod adaptor is to be used when the detector is used together with a staff or plain rod.

3. Measurement

3.1 Operating the instrument (Starting the operation)

Turn the power switch of the instrument on. This permits the rotor to rotate and an invisible laser beam to be emitted.



Note

- If the rotor does not rotate and the out-of-level warning light (orange) is blinking, the instrument is tilted, out of its automatic compensation range. Perform the (Leveling the instrument) procedure again.
- While the battery capacity warning light (red) is blinking or goes on, replace the batteries with fresh ones.
- While not in operation, be sure to turn the instrument's power switch off.
- Avoid staring at the red light source in the laser beam emitting aperture while operating the instrument. Intense light, though not blinding, is striking into the eye.

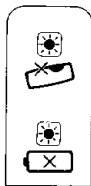
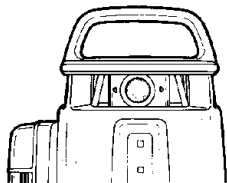

Out-of-level warning lamp

Low battery warning lamp

3.2 Operating the detector (LS 2)

(Power switch)

- ① Push the power key to turn on the power to the detector.
- ② Pushing the power key again turns off the power.

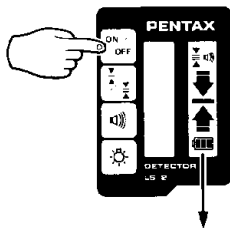

	~		Workable enough
			Less remaining capacity
			Battery is to be replaced
			Replace the battery

Note

- * The liquid crystal display all lights up as shown in the above figure with the power key pressed and held. This permits checking for any defects in the liquid crystal display. Note, however, that an erroneous display of all the symbols may happen if the battery is almost used up.
- * The battery's remaining capacity is always indicated with the power turned on. Check when to replace the battery, referring to the figure on the above.
- * The power turns off automatically if no laser beam is received and any key not operated for about ten minutes. To turn on the power again, push the power key once again.

(Selecting the reference level detecting accuracy)

Push the detection accuracy selection key to select the needed detection accuracy.

High accuracy detection: To be selected for detecting the reference level with accuracy.

Low accuracy detection: To be selected if high accuracy is not needed or when stable reference level cannot be obtained due to slight vibration at job site.

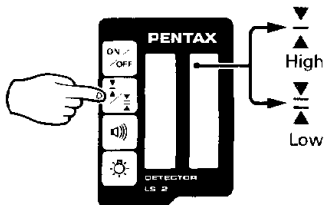

Note

- * For the detection accuracy to be selected, check with the mark in the liquid crystal display (see the figure on the above).
- * The detection accuracy alternates each time the detection accuracy selection key is pressed.
- * High detection accuracy is initiated when the power turns on.
- * If the point to be measured is distant, the reference level may not be displayed stably by the influence of heat waves shimmering or the instrument slightly vibrating. Under such conditions, select the "Low detection accuracy".

(ON or OFF of the beam reception buzzer)

Push the beam reception buzzer key to select either the buzzer sounding or silenced.

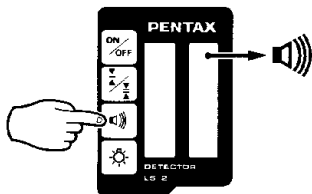

(Illuminating the display)

- ① Push the illumination key to illuminate the display.
- ② Pushing the key again turns off the illumination.

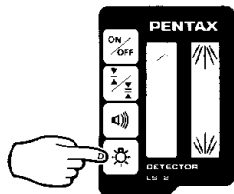

Note

- * For either the buzzer sounding or silencing to be selected, check with the mark in the liquid crystal display (see the figure on the above).
- * The buzzer sounding/silencing alternates each time the beam reception buzzer key is pushed.
- * The buzzer sounding is initiated when the power turns on.
- * The illumination turns off automatically if no laser beam is received and any key is not operated for about one minute.
To illuminate the display again, push the illumination key once more.

(Detecting the reference level)

- ① At the measuring point, set the position of the detector nearly to the height of the beam emitting aperture of the instrument.
- ② Position the detector where the beam reception buzzer sounds (or the beam reception display appears) by directing the detecting display nearly toward the instrument and moving the detector up and down.
- ③ Move the detector up and down again according to the beam reception display (or the reception buzzer) and obtain the reference level.



Move the detector down as it is positioned high.
The buzzer sound beeps at short intervals.



This is the reference position.
The buzzer sound beeps continuously.



Move the detector up as it is positioned low.
The buzzer sounds lasting beeps intermittently.

Note

- When detecting the reference level, the detector should face the instrument in the range of about 30° to the right and left from the front.

(Direct marking)

After the reference level has been detected, mark a line along the detector's index, or its top or bottom end.

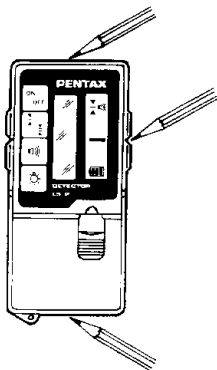

(Plain rod marking)

After the reference level has been detected, mark a line along the plain rod's top or bottom end.

Note

- * If a line was marked along the detector's top or bottom end, be sure to make measurement compensation as described on the back of the detector.
- * The detector should previously be positioned correctly on the plain rod according to the reference mark.

CAUTION

The sensor on Detector may incorrectly work when the modulated beam other than the one emitted from the instrument gets into the receiving window or when the detector is exposed to the modulated radio wave, resulting in incorrect measurement. Be sure to avoid such interference for correct measurement.

(Reading the staff)

After the reference level has been detected, read the staff, using the index on the rod adaptor.

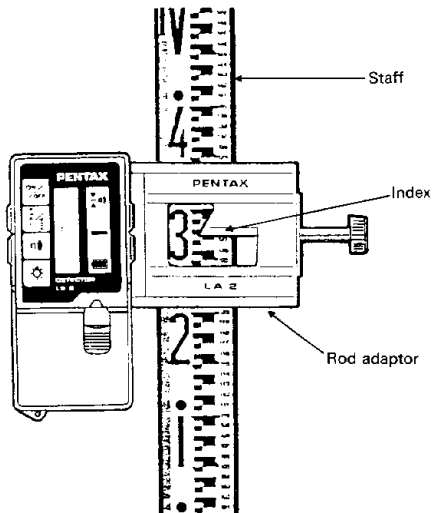

Note

When detecting the reference level, slightly loosen the fixing screw for the rod adaptor and move the detector up and down along the staff.

4. Maintenance and adjustment

4.1 Maintenance after use

(Stains on the main body)

- ① Brush dust off and wipe off moisture with tissue paper.
 - ② Clean off any stains with a soft, dry cloth.
 - ③ Excessive stains should be removed with a soft cloth soaked in a water-diluted neutral detergent and squeezed dry.
- * Do not use benzine, thinner, gasoline and other chemicals.

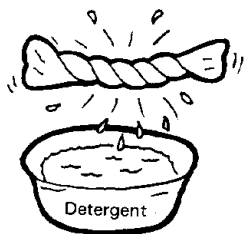

(Stains on the glass surface)

- ① First, brush dust off.
- ② Gently wipe off stains with a silicone cloth or a cleaning cloth for eye glass lenses.
- ③ Excessive stains should be wiped off with soft cotton cloth impregnated with a cleaning liquid for eye glass lenses.

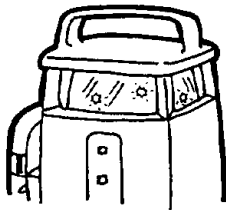

(Handling the battery)

If the instrument is not to be used for a long period of time, be sure to remove the batteries from the instrument and the detector, and then store them.



Note

- * Be sure not to use such chemicals as benzene, thinner or gasoline.
- * Be careful not to scratch the glass surface.
- * Leaving the batteries in the instrument for extended period may cause power consumption even if it is not in use.
- * If used battery is left in the battery holder, the instrument or the detector may be damaged by the battery fluid leakage.

4.2 Check and adjustment of the circular vial.

(Check)

- ① Set the instrument on the tripod and level it.
- ② Turn the power on to work the instrument.
- ③ Turn the leveling screw "A" clockwise and check to see if the rotor is turning when the bubble in the circular vial contacts the bubble circle.
- ④ Turn the leveling screw "A" counterclockwise and check to see if the rotor is turning when the bubble in the circular vial contacts the bubble circle.
- ⑤ Check the leveling screws "B" and "C" in the same manner as in the steps ③ and ④
- ⑥ The circular vial is properly adjusted if the rotor is turning in each of the steps ③, ④ and ⑤ above.
- ⑦ If the rotor is stopped in any of the above steps, proceed to the following (Adjustment) procedure.

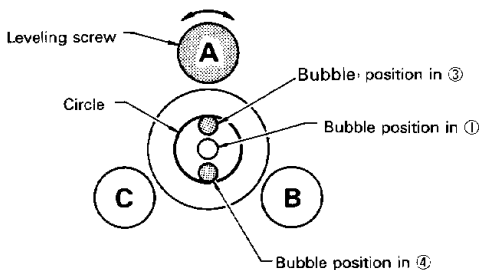

(Adjustment)

- ① Detach the bubble mirror and level the instrument for operation
- ② Turn the leveling screw "A" clockwise and remember where the bubble in the circular vial is positioned when the rotor stops.
- ③ Turn the leveling screw "A" counterclockwise and remember where the bubble in the circular vial is positioned when the rotor stops.
- ④ Turn the leveling screw "A" clockwise and move the bubble halfway between the position in ② and the position in ③.
- ⑤ Turn the leveling screw "B" to determine the position of the bubble in the circular vial in the same manner as in the steps ②, ③ and ④.
- ⑥ Turn the leveling screw "C" to determine the position of the bubble in the circular level in the same manner as in the steps ②, ③ and ④.

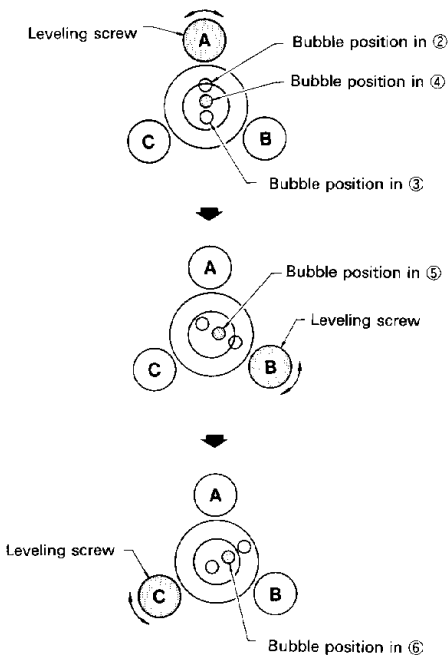

- ⑦ Turn the bubble adjusting screw with the adjusting pin and move the bubble in the circular vial to the center of the bubble circle.
- ⑧ Repeat the (Check) procedure to check if the circular vial is properly adjusted. If still out of order, repeat (Adjustment) procedure.

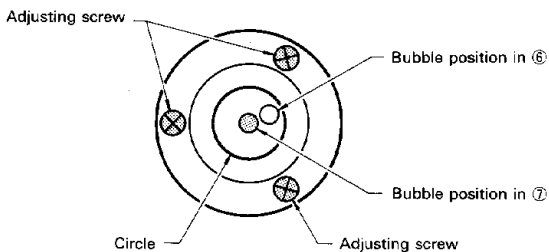

Note

- * When the adjustment is completed, check that the adjusting screw is tightened firmly.
The adjusting screw must be turned in the direction of tightening and stopped. If turned too far, reverse the screw slightly and tighten it again.

4.3 Check and adjustment of the datum point

(Check)

- ① Set up the instrument on the tripod halfway between two walls or pillars about 40m away so that the "X side" of the instrument faces the "Wall A" and level it.
- ② Operate the instrument and turn on the power to the detector. (Use the detection accuracy initially set.)
- ③ Mark the reference point detected for both walls (A,B).
- ④ Arrange a pair of target plates (with the same scale) and fix them to the walls (A and B) so that the center values of the target plates coincide with the reference point marks.
- ⑤ Loosen the center screw of the tripod to turn the instrument 180° for the "X side" to face the "Wall B", and tighten the center lock screw again for the instrument to be leveled again.

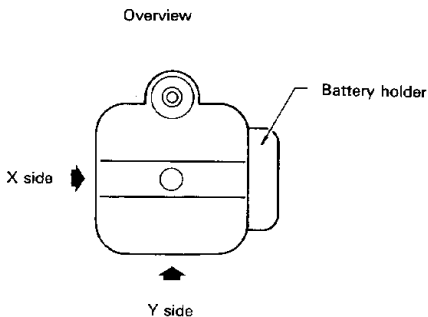

- ⑥ Read the target plates on the walls (A, B) to detect the reference points.
- ⑦ If the readings of the target plates differ less than $\pm 5\text{mm}$, the instrument needs not to be adjusted.
- ⑧ If more than $\pm 5\text{mm}$, proceed to the following (Adjustment) procedure.

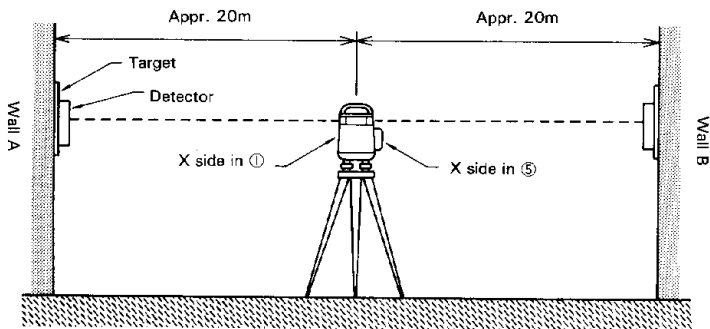





Note

- * The (Check) procedure described above is only for the "X" direction. Perform the same (Check) procedure for the "Y" direction, only replacing the "X side" with the "Y side".

4.4 Troubleshooting

(When the instrument's power switch is turned on)

 Rotor	 Out-of-level warning lamp	 Low battery warning lamp	 Detector	★ Checking point
× Does not turn	_____	_____	_____	★ Replace with fresh batteries ★ Check the polarity of batteries
	Blinking	_____	_____	★ Perform releveling ★ Check and adjust the circular vial
	_____	Lights up	_____	★ Replace with fresh batteries
○ Turns	_____	_____	× Does not detect	★ Check the detector's battery
	_____	Blinking	○ Detects	★ Replace with a fresh battery
	_____	Blinking	× Does not detect	★ Check the detector's battery ★ Replace with a fresh battery

Note

- * If the instrument is not returned to normal even through these measures, contact your dealer or authorized repair shop.

5. Specifications and optional accessories

5.1 Specifications

(Instrument specifications)

- Measuring range: (PLP-2:LS2)→Radius 0.5~300m (1.6ft~970ft)
180m(600ft)for stable detection
(PLP-3:LS2)→Radius 0.5~300m (1.6ft~970ft)
100m(330ft)for stable detection
- Working temperature range: $-20^{\circ}\text{C} \sim +50^{\circ}\text{C}$ ($-4^{\circ}\text{F} \sim +122^{\circ}\text{F}$)
- Automatic compensation range: $\pm 10'$
- Accuracy of reference beam: (PLP-2) $\pm 10''$
(PLP-3) $\pm 15''$
- Sensitivity of vial: $8'/2\text{mm}$
- Operating power supply voltage: DC3.9 ~ 6.0V
- Power supply: Dry battery (Type C), 4 pcs.
- Operation time: approx. 30 hours on alkaline dry battery
- Tripod attaching screw: $5/8'' \times 11$ thread
- Dimensions: 157(W) \times 162(D) \times 247(H)mm
- Weight: 2.5kg

(Detector LS2)

- Detection accuracy: HIGH : $\pm 1\text{mm}$
LOW : $\pm 2.5\text{mm}$
- Beam reception indicator: Liquid crystal display/buzzer
- Sensitivity of vial: $90'/2\text{mm}$
- Power-supply voltage: DC9V/dry battery (6F22 or 6LF22)
- Operation time: Approx. 50 hours on alkaline dry battery (6LF22)
- Auto power off: Power supply: Approx. 10 min.
Illumination: Approx. 1min.
- Remote display terminal: Provided
- Dimensions: 78(W) \times 30(D) \times 160(H)mm
- Weight: 250g

5.2 Optional accessories

(Remote display LR2)

- This is used to observe the light reception display of the detector from a distant place.

(Plain rod adaptor LH2)

- This is used to attach the detector to a plain rod.

(Large-sized case)

- This case can house the standard configuration and an additional detector, so it is useful for storing or transporting the instrument together with an additionally purchased detector.

6. Notice to the user of this product

To assure compliance with the Safety standard 12 CFR, Chapter 1. Subchapter J, The U.S. Bureau of Radiological Health requires the following information to be provided to user:

1) Specifications of Laser Radiation

A. This laser system is designed and built to have a GaAlAs laser diode radiating at $780 \pm 15\text{nm}$.

B. Radiant power

This laser product is designed and built to radiate a maximum average radiant power of $6\mu\text{W}$ as scanning beam during functional operation.

The user may be subjected to this radiation as a scanned beam while the rotor is rotating until such time that the instrument is turned off.

* For a period of less than 10 seconds during operation the user may be subjected to this radiation.

2) The following labels are affixed to and must remain attached to this laser product.

A. Certification label

"This laser product conforms to the provisions of 21 CFR 1040.10 and 1040.11. For a class 1 laser product."

Located on the surface of the base of top-handle

B. Caution label

"Laser beam, do not look into the laser beam source directly."

Located near to exit aperture, facing upward.

3) Caution to maintain the safety in compliance with the standard

* To maintain the safety standard, refrain from any operation, maintenance or adjustment other than described in this instruction manual.

* Operator, maintenance or adjustment other than those specified in this instruction manual may result in hazardous radiation exposure.

* Maintenance and repair not covered in this manual must be done by an authorized Pentax dealer.

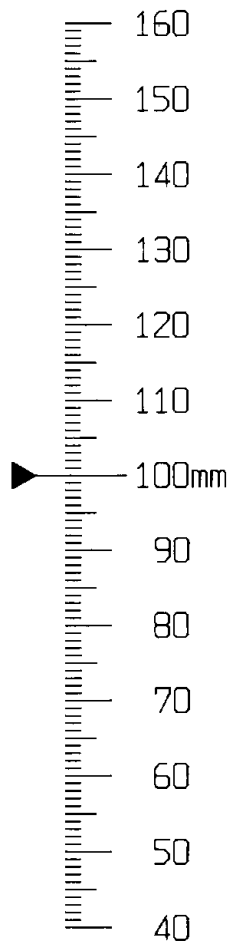

PENTAX

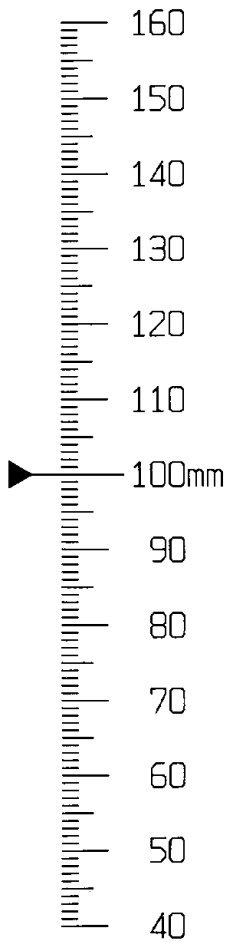

PENTAX

PENTAX

ASAHI PRECISION CO., LTD.

Miyakezaka Bldg., 1-11-1 Nagata-cho,
Chiyoda-ku, Tokyo 100 Japan